



# **The Talbot Manual**

## **Technical Resource**

# **Electrical System**

**Bill Barrott & Martin Bryant**

*This publication has been produced by the Talbot Owners' Club Ltd. in good faith, and the information contained therein does not necessarily reflect the views of the Club or Officers, who cannot be responsible for loss or damage for work carried out or actions taken by members, based on these contents.*

# ELECTRICAL EQUIPMENT ON TALBOT CARS

TALBOT cars are fitted with a Rotax dynamotor. It is coupled direct to the front end of the crankshaft. The machine serves a dual purpose, supplying the current for starting the engine, and when driven by the engine above a certain speed, generating current to charge the battery. In the latter case, when it is functioning as a dynamo, it generates an output of approximately 15 amperes at an engine speed of 1750 r.p.m.

The dynamo is a reliable unit and requires little attention, although occasionally the brush gear and commutator should be inspected. Access to these parts is obtained by removing the shield and taking off the dynamotor cover. The surface of the commutator should be kept clean and free from oil or carbon dust, and when a car has been in use for some considerable time it may be necessary to clean out the grooves between the copper segments, using a thin saw blade or similar implement for the purpose. On no account should emery cloth be used.

There are four main brushes of equal size and one regulating or demagnetising brush of thinner carbon. All the brushes should slide freely in their holders and should "bed" over the whole surface in contact with the commutator. If it should be necessary to replace a brush it is important that the correct grade of carbon brush should be used, and this should be obtained from the Rotax Company or one of its service depots. Generally speaking brushes require replacement when worn down to about half their original length, *i.e.*, when half-way down the brush holder.

When replacing a brush see that the nut holding the small "pigtail" tag in place is quite tight and that the depression lever is in its proper position on the top surface of the brush and the spring tensioned on it. There is a small greaser accessible under the front shield which lubricates the front bearing of the armature. This should be given about one turn every six months. The armature is mounted on ball bearings which are lubricated with a high melting-point grease. As these bearings are properly packed with lubricant when the unit is assembled, it will not be necessary to repack except when the car has covered a considerable mileage and is receiving a thorough overhaul.

It should be pointed out that the dynamotor is designed for starting the engine under normal conditions and any unnecessary or additional strain is likely to diminish the life of the battery. Always make sure that the ignition is switched on before attempting to start the engine, and in exceptionally cold weather, or if the car has not been used for any length of time, first flood the carburetter by means of the hand priming device fitted to the petrol pump, and then turn the engine over slowly for a few revolutions with the starting handle. This will ease the pistons and induce a supply of gas so that there will be less load on the starter when the starter switch is pressed.

The battery, which is a most important unit on a car and therefore should have regular attention, is carried in a steel container under the floorboards. It is advisable to look over it about once a month and remove the vent plug so that the level of the acid can be seen. The plates should be fully covered but if the level has fallen, due to evaporation, add distilled water until the tops of the plates are just covered. Do

not use tap or rain water for this purpose. The battery terminals should be kept clean and tight and smeared lightly with vaseline to prevent corrosion. Always keep the battery well charged. Car batteries are seldom damaged through overcharging; much greater harm is caused by undercharging.

On the engine side of the dashboard there is a junction box which contains the fuses and forms the main distribution point for most of the cables. There are three fuses, a main dynamotor fuse, a dynamotor shunt field fuse and an accessories fuse. Spare fuse wire is provided in the cover. The fuses and terminals can be easily inspected by removing the cover of the junction box, which is retained by two screws and nuts. In replacing the cover care must be taken not to bridge any of the terminals or a short circuit will occur. A cutout or automatic switch is fitted on the junction box, the purpose of which is to connect the dynamo to the battery when the voltage generated by the dynamo exceeds that of the battery, and also to disconnect them when the dynamo ceases to generate. This cut-out is carefully adjusted and accurately set before the car leaves the Works and should not be interfered with.

The Talbot ignition system is the latest design of Delco-Remy coil ignition distributor. The coil is never likely to require attention, in fact it should not be interfered with in any way, except occasionally to see that the leads are held tightly in position. The distributor is fitted with a full automatic advance controlled by the speed of the engine. This device is non-adjustable.

The contact breaker mechanism, which is accessible by removing the domed cover of the distributor and pulling out the rotor, is shown in the accompanying illustration. "A" is one of the two contact breaker arms. The contact breaker is designed to work with a .018 in. gap and this should be checked periodically. To set the gap with the arm "A," loosen screw "B" and turn screw "C" until the correct opening is obtained, then tighten screw "B." The gap of the other arm "D" is set by loosening screw "E" and turning screw "F" until the correct opening is obtained, and then tighten screw "E." The screws marked "G," "H" and "J" should not be touched except by the makers or one of their official repairers. These screws are provided for synchronising the points when a new contact breaker arm has been fitted, and a special tool is essential for effecting this synchronisation.

The points of the circuit breaker assembly should be kept free from grease and the face of the cam lightly smeared with vaseline about every six months. The circuit breaker arm pin should receive similar treatment at the same time, and the felt ring insert in the cam should be moistened with a spot of light oil to ensure the free working of the automatic mechanism.

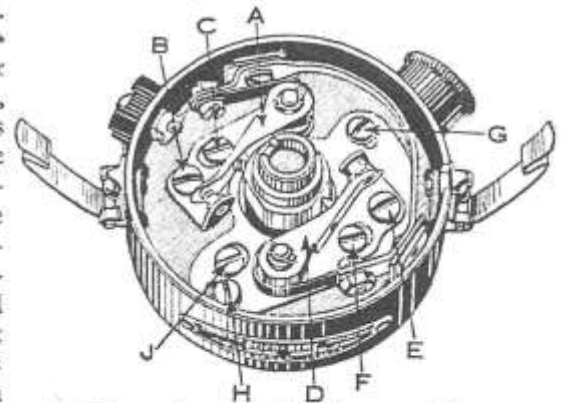

# LET THERE BE LIGHT

By Martin Bryant

*(The layman's guide to the eccentric electrics of Georges Roesch)*

What does a red light mean to you? Universal stop symbol? Sign that an illicit good time awaits within? Or the dreaded reminder that your dynamotor is not charging?

Readers of my earlier scribblings will remember that the 'bloodshot eye' has haunted me from Scottish glen to Alpine peak. Trying to understand why has taken me on a voyage of discovery to the far reaches of the Rotax electrical system. With apologies to those that have trodden these shores before, I present my laymans findings in the hope they may help others who are put to the test.

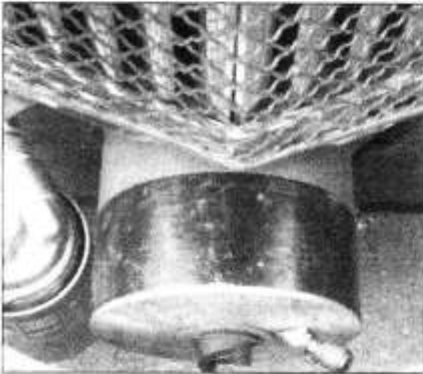

*Above: The Talbot Dynamotor*

It all starts with a paradox – a 'trade off' in modern parlance. On the one hand the elegance of a single machine performing two functions. On the other the inevitable compromise that follows when an idea is pursued beyond its logical conclusion. It goes back to those 'O' Level physics classes you grappled with. Turn a coil of wire through a magnetic field and you have an electricity generator (or dynamo). Pass electricity through the same wire and you have an electric motor (or starter). Combine the two in one machine and the 'dynamotor' leaps out as the smart solution to the starting and battery charging needs of the motor car.

So saw Georges Roesch as he laid out the seminal design of the 14/45 in 1926. By coupling the machine directly to the front of the crankshaft he achieved the silent starting for which Talbots are renowned and eliminated the need for unreliable belt or gear drives. But herein lies yet another compromise. Direct drive limits the dynamo to engine speed and at the same time deprives it of the ability to use gearing to turn the engine. Hence it rotates too slowly to be an optimum generator and requires massive torque to be an effective starter.

For a 1926 1600cc low compression engine the limitations were containable. By the 1930s, 3000cc, higher compression and a pre selector gear train meant the Talbot was a turgid starter on cold mornings. Hence the next compromise - stick 24 volts through it for starting but keep it generating at 12 volts. Simple in concept, hideously complex in operation. This is the nightmare world of the Talbot 95/105/110 Rotax electrical system.

Where to find 24 volts? Easy – add another battery and connect them in series (positive to negative) to create one 'uber' battery. Fire the current down a big cable to the dynamotor and Bobs your Uncle. Well not quite, because we only need 12 volts for the rest of the system. So disconnect the batteries and re-attach them in parallel (positive to positive) so the Talbot can run as a normal car. Welcome to the Rotax solenoid, a fiendishly clever mechanical device that switches

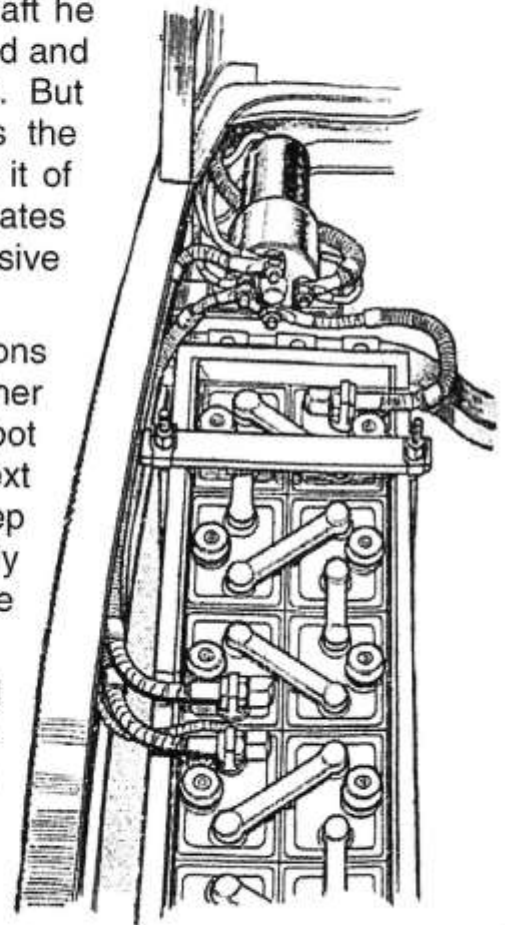

*Above: Twenty four volts with 2 batteries and the Rotax solenoid.*

batteries around, transmits vast amounts of current and eighty years on serves you up some nasty tricks.

The final star in the electrical drama is the cut out or twin coil reverse current relay in polite circles. In layman's language it is an electro-mechanical switch which allows current to flow to the batteries when the time is right and not when it isn't. It too has its fair share of surprises.

Supporting the main cast are the minor players of ammeter, fuses, junction box, ignition switch, starter switch and of course the red light itself. In all an amazing collection of carbon, aluminium, steel, copper, glass, bakelite and brass with nearly one hundred connections to ensure your red light goes off at the right time and comes back on when it should.

Starting with the lead actor – the dynamotor. It is bolted to the crankcase and weighs about the same as my 10/23 engine. You can't miss it! The bit we are interested in is at the front, reached by removing the detachable band. This is the commutator – 85 copper segments that carry the generated current and pass it through four large carbon/copper brushes. These are connected internally to terminal 5 on the dynamotor casing, from whence leads a thick wire. In generate mode the brushes collect current and pass it down this wire for onward delivery (hopefully) to the two batteries. In start mode 500+ amps hurtle down the same wire, through the brushes and force the dynamotor to turn the Talbot engine. With that amount of current flying about the front of a dynamotor is not for the shy and retiring.

This though is not the end of the story because there is a fifth brush. It is definitely the runt of the brush family – barely half the size of its four brothers. But without its co-operation nothing happens. In the electrical jargon it is the 'exciter' brush (or have I got the wrong red light here?) It creates the magnetic oomph in the field coil that allows the generator to generate and, through the cut out, connects the battery to the dynamotor at the right time. Are you still with us? The right time is when the dynamotor is generating more than 12 volts (above 800rpm) which allows it to stuff electricity into the batteries. The wrong time is when generation is less than 12 volts and the battery would discharge through the dynamotor. Hence the need for a cut out and why the red light comes on at low revs.

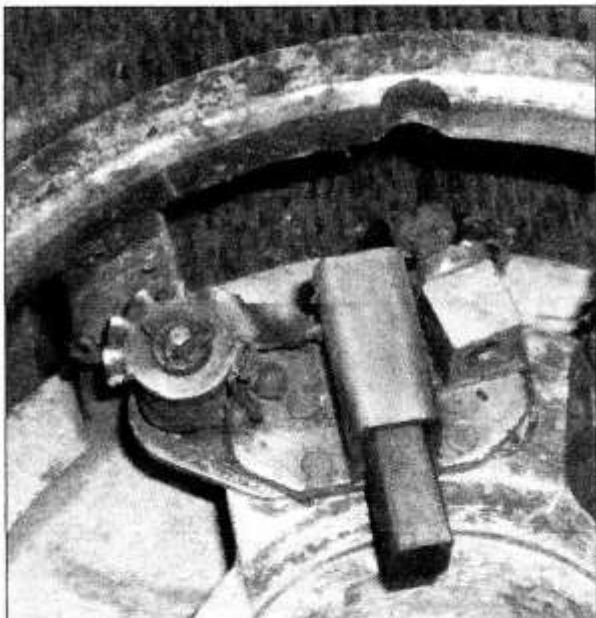

*Above: One of the brush holders, showing the brush which must move freely in its holder and also the notches to set the spring pressure. This ensures good contact is made on the commutator for trouble free starting and charging operation.*

Maintenance of the brushes is just like any dynamo, only bigger and less accessible. The commutator must be clean and free of carbon dust, particularly between the segments. The brushes must be long enough (1"), move easily in their holders and have enough spring pressure (16-20oz.). Done in situ this is a b----r of a job involving access through small slots in the dynamotor casing, improvised tools and much swearing. The fifth brush is the master when it comes to inaccessibility. It is located in the bottom slot, so you are lying on your back working above your head. Its position relative to the main brushes determines the charging rate. This is definitely not a case of 'more is better'. Too high a charge rate will over fill the batteries with electricity and create

enough heat to melt the solder in the machine. The fifth brush holder is attached to an aluminium ring clamped by a screw accessible through the top slot. Slacken this and move the brush holder clockwise (viewed from the front) to reduce output and anti-clockwise to increase. Small movements (1/8") make a big difference. The expert view is to aim for 10-12 amps which will balance headlights, coil and sidelights. Don't overtighten the clamp – it is 80 year old aluminium! For diagnostic tips see Arthur Archer Technical Sheet AA7. (*Arthur Archer Technical Sheets are from the Archer Archive available on the TOC forum*)

The smaller engined cars (with single battery) have a resistor built into the dynamotor (terminal 7A) which allows for half charge on the dashboard switch. This sensible feature is omitted on the larger cars, on the assumption that two batteries sharing the output equals de facto half charge anyway. Many owners have wisely achieved greater control of the charging rate by putting resistors or 'on/off' switches in the field circuit. See Michael Marshall's erudite articles in the TOC Magazine for more illumination.

Next in the cast of characters, in terms of size and weight at least, is the solenoid. Remember this is the clever gizmo that makes your car 24V or 12V at the right time. It is located behind the engine, bolted to the chassis frame and has four big wires coming off the back. Electrically it sits between the dynamotor and the batteries. Capable of pounding out 500amps to start the beast and then tenderly relaying the 10 charging amps to the two batteries. In the former mode it is pretty bullet proof. Two huge copper contacts being thrown into engagement and pulled apart by a large spring. In charge mode it is a different story. A secondary pair of lightweight contacts come into play and take the precious charging current that passes via the ammeter and distribute it to the two batteries. These contacts can burn and are the source of difficult to diagnose charging problems. If all else is okay suspect these contacts. Replacements available from AA.

The cut out is an absolute lightweight compared to the dynamotor and solenoid. This belies its importance in the charging circuit and not for nothing is it known as the 'naughty box' in our family. It is located on the bulkhead – a square metal box above the fuse panel. Switching is done via a contact breaker – the points pulling together when the voltage is greater than 12 and springing apart when it is less. Arthur Archer Technical Sheet AA3 gives helpful diagnostic tips but other than checking for tightness of connections and adjusting the pull off spring pressure there is not much for the layman to do.

Of the supporting cast 'fuse box', son of 'naughty box', comes closest to stardom. It contains the field fuse (7) and main fuse (5). These are easily visible and no charging will occur if either malfunctions. It also hides a dark secret. Behind the fuse panel is a critical soldered connection from terminal 7 to terminal 5. Three quarters of a century of vibration can break this link and produce no charge. Many a reliable Talbot



*Above: A pulley fitted on the end of the dynamotor driving an alternator mounted underneath it.*

bypasses it with a short length of heavy gauge wire. Needless to say all connections should be tight, wire checked for shorts etc.

In the end even Georges Roesch had to bow to the inevitable. His elegant, but compromised, electrical system was replaced in the 1936 model range by a conventional starter motor and dynamo arrangement. The name Lucas appeared on Talbots for the first time. The light had arrived!

Eighty years on and many have been the responses to Mr Roesch's challenge, including Ian Polson's late sump conversion (a complete solution), and John Dodd's pioneering of a Mercedes van 12/24V change over switch to replace the Rotax solenoid. Others have escaped the tyranny of the fifth brush by adding modern dynamos or alternators wherever they can find a spare drive pulley or gear.

For the rest of us we grin and bear it. Rejoicing in the silent starting and praying that the red light stays off. Smug in the knowledge that no other car on earth has an electrical system like ours!



# The Talbot Electrical System

## General Description

The majority of Roesch Talbots have a highly eccentric electrical system when looked at from today's perspective. However they are not so unusual by the standards of late vintage practice. Generation and starting are provided by one unit – the “dynamotor”. On the 14 and 18hp cars this operates entirely in 12v mode with a single battery. On the 21 and 23hp cars a second battery is added to give 24v for starting, but 12v for charging. This switch over is handled by a special solenoid. Current passes through a fuse protected junction board and is controlled by a twin coil reverse current relay. Known as the “cut out” this operates on the constant current principle. All items are made by Rotax.

The notable exception are the cars produced from October 1935 onwards (BD, BG and BI chassis models) These are deeply conventional (i.e. modern) with separate dynamo and starter motor, all Lucas equipment and voltage regulated current control. They are not covered by these notes, as maintenance and repair should hold no fears for anyone raised on 1950s and 60s “Prince of Darkness” equipment.

## The Dynamotor

### Description

There are two types of dynamotor fitted to Talbots – the 14hp cars use the smaller diameter (5&3/4 in) DM6 with one charging rate and later cars the DM10 or DM11 with half charge facility. Bigger cars use the larger bodied (6&1/2 in) DM 9 in various forms. Some with half charge and those on 12/24 volt two battery systems without. All dynamotors work on an identical system with four main brushes for charging and starting and a fifth charge control brush. This is commonly known as the “three brush” system and was the standard form of automotive electrical charging until 1936.



The front face of dynamotor showing removable brush cover



The rear face of dynamotor showing crankshaft engagement dog



The main terminal at front of dynamotor. This receives 24v in start mode on 21hp cars



The field terminal at rear of dynamotor. This is always at 12v on all cars

## Access

Access is gained by removing the front apron. These notes will concentrate on jobs that can be undertaken with the machine on the car. Removal is obviously required for full overhaul. On most cars this necessitates taking off the radiator to access the securing bolts. The weight of the dynamotor requires careful handling and if any doubt use a jack or sling. When you replace it remember to check the gasket and put sealing compound on the bolt threads or oil drips will be a constant plague.

The first task is to remove the steel band that covers the brush gear. This is held by 2 screws and must be replaced so that the join is on a solid face to prevent water ingress. Check that the paper insulating lining is intact.



Access brush gear by undoing two screws and sliding steel band forward



Check paper insulation is intact



Refit band so join is on a solid face

## Cleaning

You are now able to do the first and most important task on a Rotax dynamotor – clean it! This should be an annual chore and the best access is from underneath, alongside the fifth brush holder. It is a decidedly unpleasant activity as the regular application of 550 starting amps produces a lot of filthy carbon dust. Blow through with an airline and then set to with an aerosol of electrical switch cleaner and improvised swabs and scrubbers. The aim is to get the commutator back to gleaming copper. If it is very dirty use fine glass paper or wet and dry. Scrape the carbon out of the 85 commutator slots with a sharp instrument, such as a ground down hacksaw blade. Doing this job thoroughly will set up many years of reliable use.



## Brushes

Next make yourself an improvised hook and pull back the brush retaining springs. Pull the brushes out and inspect their faces. They should be slightly curved to fit the commutator and show a uniform polished appearance without any missing chunks. New brushes are one inch long and brushes should be replaced when they have worn to three eighths of an inch. Check that the brushes move easily up and down their holders. Binding brushes are a common cause of erratic starting and charging. If there is any friction ease the brush by rubbing with glass paper. Whilst the brushes are out check the spring pressures. On the four main brushes these are quite strong (up to 20oz.) and can be checked with a small spring balance. Adjustment is made by moving the engagement spring to an alternative notch – quite fiddly with the restricted access. Make sure you replace the brushes the same way round so as to maintain proper bedding on the commutator.

The fifth brush is half the size of the others, but vitally important as it controls the charging current. (To understand the theory read any automotive electrics textbook on the three brush dynamo.) Check its operation in the same way as the main brushes but set spring pressure to 10-12 oz. Any stiction on this brush will result in no charging, even if the machine works fine as a starter.

Brushes can be replaced with the dynamotor in situ. They come with straight edges that need to be bedded to the shape of the commutator. This can be done by wrapping a strip of emery paper around the commutator – abrasive side upwards. Insert the new brush and whilst maintaining downward pressure rock the commutator to and fro on the starting handle. This is a fiddle some job and much easier done with the dynamotor on the bench or by making up a jig with a piece of pipe the same diameter as the commutator. However you do it, don't neglect the exercise as the straight brush edges will achieve poor contact and cause heavy sparking.



Improved hook to pull back brush retaining springs



Spring held back and brush being eased out of holder



Check brush length. New brush is 1 inch long



Check face for polished and even appearance

There are two adjustments that can be made to the dynamotor. The first is to set the position of the main brush holders relative to the case. This should only need to be done at a complete strip down. Adjustment is made by slackening the inner screw at the top, front of the dynamotor – access gained through a window in the casing. This allows the brush holder mechanism to be rotated so that the edge of the upper holder aligns with the centre of the bolts on the casing (see diagram). Close inspection may reveal two red paint lines inside the front of the dynamotor. These should align when the brush holder is correctly positioned.

The second adjustment governs that rate of charge by fixing the position of the fifth brush relative to the main brushes. This is set by slackening the outer of the two screws and moving the fifth brush holder clamping ring. Moving in the direction of rotation (i.e. clockwise when viewed from the front) increases charge rate and anti clockwise reduces it. Small movements make a big difference so don't go more than one eighth of an inch at a time. The best advice is to set the amperage to balance the running load on the car electrics at night\*. This is usually 10-12 amps on the car ammeter. Better to set with ammeter between cable and main terminal with no external loads at 14/15 amps.

*\*To calculate current in amps remember your 'O' level physics :*

*Current(amps) = watts/volts.*

*Lighting loads are typically : headlights 36w x 2 = 72w : side lights 6w x 4 = 24w : instrument lights 5w x 4 = 20w. This gives 116w / 12volts = 9.6amps. Add another couple of amps for coil and possible electric fuel pump and you get to 12amps.*

The machine has a maximum output of 15.5amps. It is unwise to run at this output in deference to its age and the impact of charging current in daylight running. Take great care not to over tighten the clamping screws as the retaining rings are alloy and eighty years old!



Set edge of brush holder in line with bolt centres



Red paint or punch marks sometimes show correct alignment



Inner screw adjusts main brush holder. Outer screw adjusts fifth brush



Slacken fifth brush screw and move ring in small increments

## DYNAMOTOR TIPS.

BRUSHES MUST BE CORRECT COPPER/CARBON COMPOSITION.

BRUSH POSITION IS CRITICAL & USUALLY MARKED BY THIN RED PAINT LINE ACROSS BOTH BRUSH HOLDERS & REAR COVER. TO CHECK POSITION OF 4 MAIN BRUSHES —

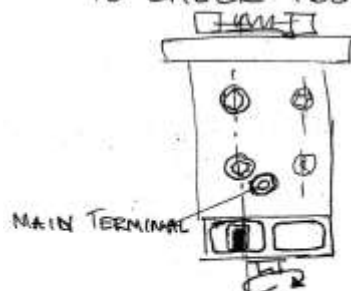

☞ OF FIELD COIL FIXING BOLTS SHOULD CO-INCIDE WITH EDGE OF BRUSH AS SHOWN.

(NORMAL ACCEPTED POSITION WOULD BE ☞ OF BRUSH)

ADJUST 2<sup>nd</sup> BRUSH TO GIVE 12 AMPS @ ABOUT 1500rpm & 14.5/150 VOLTS.

Any other work on the dynamotor i.e. rewinding coils, replacing bearings or resurfacing commutators is the preserve of experts and well beyond the scope of these notes. It may all sound rather complicated, but the moral is simple – keep it clean and keep the brushes moving smoothly and you should expect another 80 years of loyal service.

### Diagnosis

There are a limited number of diagnostic tests that can be done with the dynamotor on the car. You will need a voltmeter reading to 20v or a 36 watt bulb with two flying leads.

The first test should be done with the engine running. Connect the voltmeter or lamp between the main terminal at the front of the dynamotor and earth. As speed rises voltage should increase to 20v or the lamp glow brightly. If this does not happen there is a break in the field circuit, so proceed to test two.

Still with engine running disconnect field wire from the rear of the dynamotor and connect the field and main terminals with a short length of wire. Leave the field wire disconnected. Attach voltmeter between main terminal and earth. If it now rises to 20v there is a fault in the external field circuit i.e. wiring, fuse, fuse clips, cut out etc. Carry on a systematic check in these areas. If it does not rise beyond 2/4 volts the fault is in the dynamotor. Remove the cover and check all brushes as previously described, with particular attention to the fifth brush.

On the bench there are two quick checks that can be done using jump leads and a 12v battery. To test starting functionality earth body of dynamotor to the negative terminal of the battery and attach positive lead to the main terminal. The dynamotor should rotate at an increasing speed. To test charging functionality connect the field terminal to the main terminal. The dynamotor should now rotate and at a slower and constant speed. If it does not do so there is a fault in the field coil and expert attention is needed.



Test starting with positive to the main terminal



Test charging by connecting field and main terminals

# THE ARCHER ARCHIVES

## AA 7 - ROTAX DYNAMOTOR

Rotax 12/24 volt Dynamotor Type D.M.9. Very heavy. Usual dynamotor circuit, 3 heavy series field coils (starting), 3 light shunt field coils (charging). Armature has 85 commutator bars (automotive record?) 17 slots. Wave wound.

Brush spring tension (main) 16 - 18 ozs  
Brush spring tension (field) 11 - 13 ozs } This is critical.

Brushes are of a copper-carbon mix. Substitution of plain carbon material produces a reduction of some 19% of locked up torque.

Brush dimensions: Main : 5/16" wide x 5/8" long (axially) x 1" high (radially)  
Field : 3/16" wide x 5/8" long (axially) x 1" high (radially)  
Both types have a flexible connection with a 2BA eyelet.

Bearing dimensions: Drive end: 35mm x 80mm x 14mm  
Comm. end: 3/4" x 1 7/8" x 5/16" RLS6

Starter lock torque: 2 x 12v batts. 85 lbs.ft. at 12v.  
1 x 12v batt. 45 lbs.ft. at 8v.

The shunt field was wound to influence the lock torque. Typical figures - with shunt field 90 lbs.ft. - without shunt field 78 lbs.ft.

Therefore, for best results brushes should be copper-carbon mix, properly bedded and the external field circuit should be complete. On the vehicle it is beneficial to fit an engine/chassis earth band. Makers figures 85/95 lbs.ft. at 11.5v and 520 amps. 8 H.P. or with 50% efficiency say 4 H.P.!!

In its charging mode the following particulars apply:-

Cut in : 650/750 rpm 12 dynamo volts

Max. output : 14.5/15.5 amps @ 1,400/1,600 rpm 16 dynamo volts

The D.M.9 uses two 12v batteries in series for starting. For charging they are connected in parallel, therefore each battery received HALF of the indicated output. The change-over is controlled by a special (unique?) solenoid, the Rotax SOL/CT8.

Overhaul of the D.M.9 is not very different from that of any other electrical unit except in the size and weight of the components. If the bearings feel in good condition, the armature is removed by taking off the starter dog, lifting the brushes, and undoing the ring of cheese headed screws which are sunk into the thickness of the back flange. Gentle tapping with nothing firmer than a block of wood should ease the armature out to the rear. If necessary the front casting may then be removed by undoing the cheese headed screws visible in the brush gear access slots. Take notice that you have to undo the heavy series cable and the lighter field brush connection before the end can be taken completely away. Notice that both the four main brush holders and the field brush holder can be assembled in any position on the casting; therefore if the thing is known not to have been disturbed, it is best to mark the positions of the brush holders before you take them out. The field brush may be moved to vary the charge output, turning it in the direction of rotation increases the output. This adjustment is quite sensitive and is best set to just balance the lighting load plus the screen wipers.

Electrical testing of this unit follows standard practice. Make sure that the field coils are all rigid and test all insulation including the brush holders, for leaks to earth.

If the commutator is ridged, it should be re-machined true and the micras undercut. The brushes should be bedded in, using a strip of No.320 Wet and Dry paper wrapped around the commutator. Mark each brush before you bed it in for correct assembly. Cease bedding in as soon as you have

marking all over the end of the brush. All electrical connections must be clean and tight. These units carry a lot of amps and any bad connections soon result in overheating and unsatisfactory operation. (If re-wiring, keep to the original section of cables).

The driving dog is secured to the shaft with a taper and a key and as the taper is fairly steep it usually yields to a suitable extractor without any trouble. The bearings should be packed with high melting point grease and renewed if they are at all harsh.

When the thing is assembled on the car a surprising amount of noise can emanate from faulty dynamotor bearings. A rough test of the unit off the car with a 12v battery is as follows:-

Negative battery to frame of machine  
Positive battery to main terminal

Whereupon the machine should motor quietly at (guessing) 600-800 revs. Connect the main terminals to the field terminal and the thing will continue to rotate but at a much reduced speed, say 100 revs. If you do not have this distinct change in speed, there is a break in the charging field circuit and it will not charge when fitted to the car.

The 75/90 has a 12 volt unit. Mechanically it is exactly the same as the unit fitted to the larger cars. Externally it appears identical, whether the windings are different I do not know, nor do I know if you can interchange the two types with impunity (and a crane!)

### Settings and adjustments for the dynamotor

#### Setting the main brush holder on the Rotax D.M. 9 Dynamotor

1. Set as shown - machine will motor on open field circuit at about 1500 r.p.m. On connecting field terminal 7 to main terminal 5 speed should drop to 400/500 r.p.m.
2. Should speed fail to drop a break in the field circuit is indicated.
3. Once set main brushes should not be moved.
4. Adjustment of charge rate should be made on fifth brush only (see setting the 5th brush).
5. Do not overtighten brush holder clamp screw it is all too easy to break the aluminium clamp.

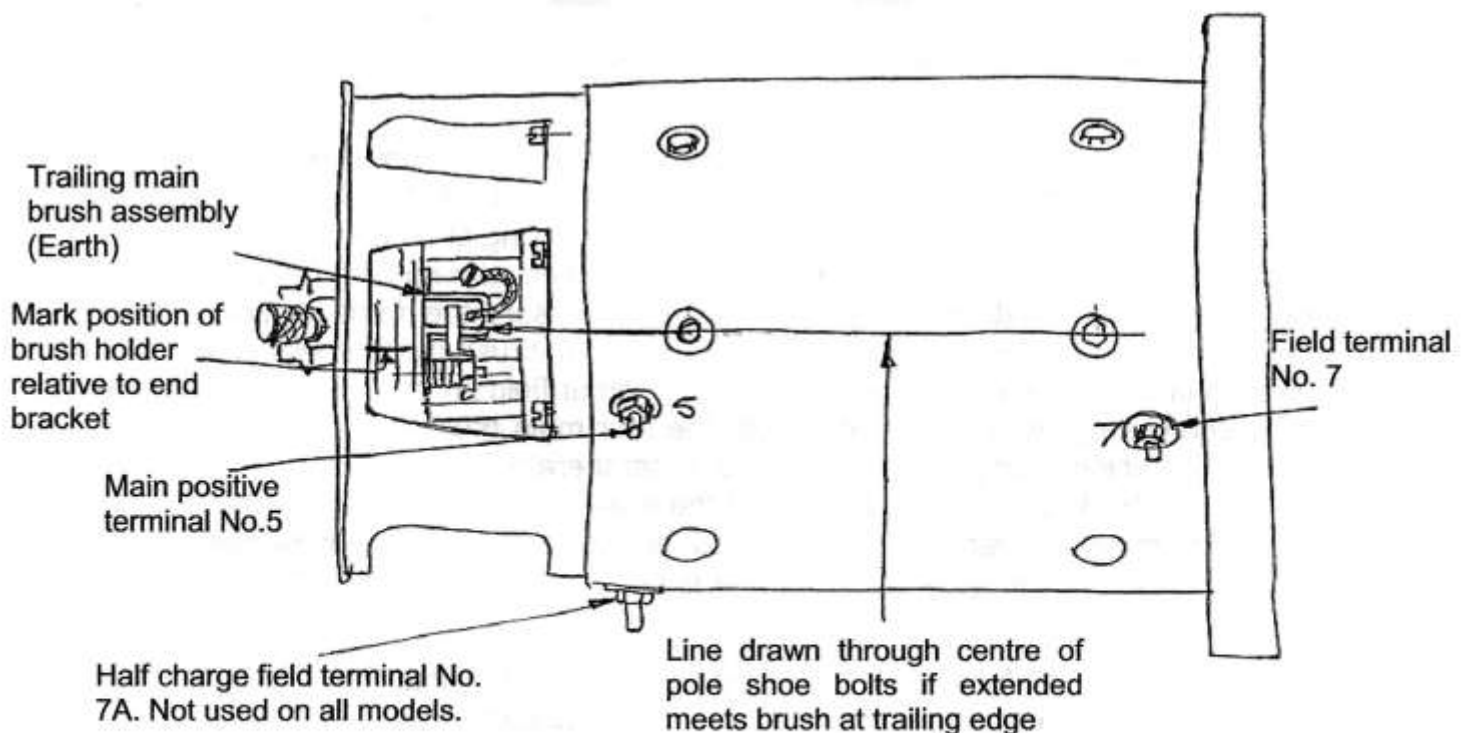

Diagram to illustrate main brush holder setting.

## Setting the 5th (field) brush on the Rotax D.M. 9 Dynamotor

1. To increase charge move the 5th brush in direction of rotation, it is quite sensitive - only move brush 1/16 inch at a time.
2. To minimise heat and general wear and tear do not set output any higher than absolutely necessary if car is used only in day-light. Reduce output to 10/12 amps. \*\*
3. Do not overtighten brush holder clamp screw - it is all too easy to break the aluminium clamp.
4. For main brush setting see setting the main brush instructions.

\*\* If car has 1/2 charge position on switch - use it! It operates by inserting a resistor into the field circuit. This resistor is located within the dynamotor if the terminal 7A is present. 75 models were equipped with 1/2 charge, 95, 105 and 110 models were not.

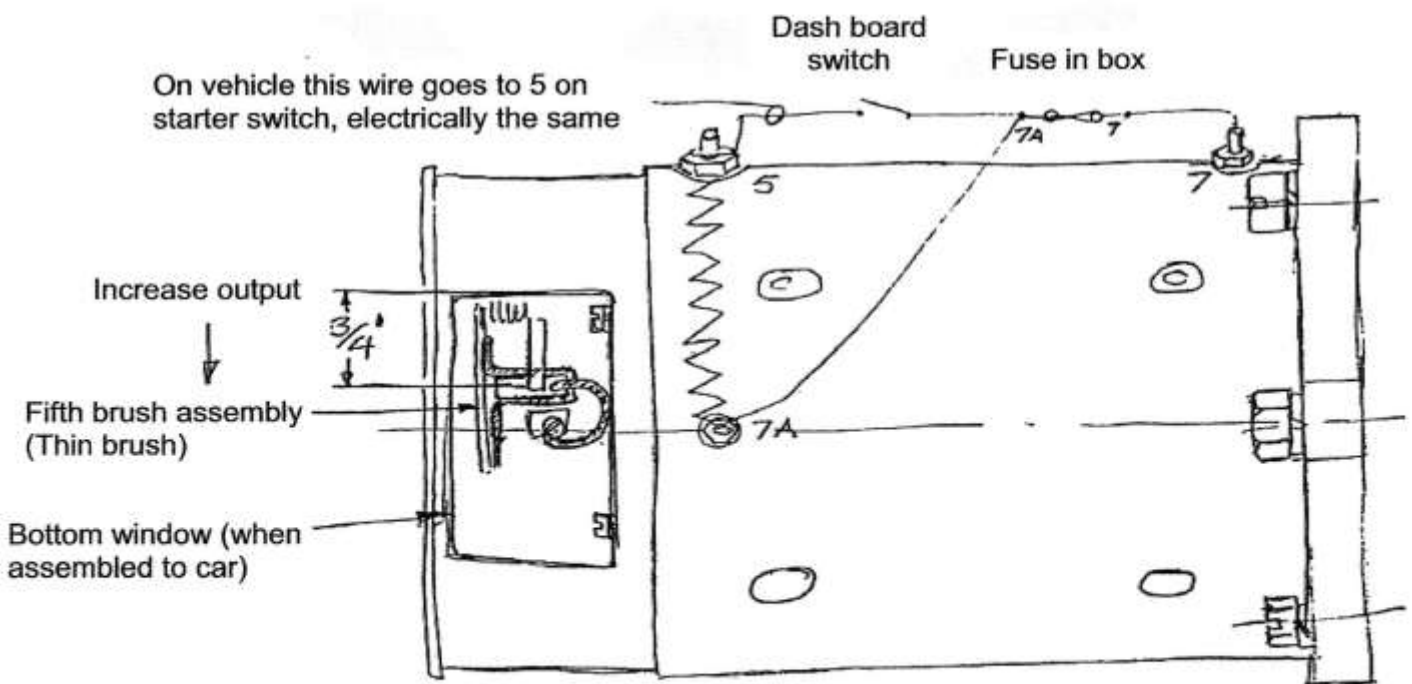

Diagram to illustrate 5th (field) brush setting.

## AA 3: TALBOT 12/24V DYNAMOTOR TO CHECK FOR 'NO-CHARGE CONDITIONS'

\*For 12v Dynamotors ignore the paragraph in brackets

I list a few tests you could carry out which might bring you to the source of the trouble.. You will need a volt meter reading up to 20 volts or, failing that, a 36 watt bulb with two loose leads.

The first test should be with the engine running. Connect the voltmeter between the dynamo positive terminal (the heavy one) and earth. If all is well, as the speed rises the voltmeter should quickly come up to a full-scale reading or the lamp should burn brightly. If the voltage remains stubbornly down at 2/4 volts, it denotes a break in the field circuit, so proceed to test two.

Disconnect the field wire from the rear of the dynamo and join the field and positive terminals with a short piece of wire. Leave the field wire from the chassis disconnected. If the voltage now rapidly rises to 20 volts it denotes a fault in the external field circuit i.e. chassis wiring, fuse clips, the fuse itself etc. If the needle still refuses to budge, the fault is in the dynamo and there is only a limited amount you can do to this on the vehicle.

First thing to do would be to remove the cover and check that the field brush (the thin one) is perfectly free in its holder and well bedded on to the commutator. If you take the brush out, make sure you put it back the original way round. Check all the other brushes while you are at it. Although, if the thing is functioning as a starter, I should not expect there to be any trouble with the main brushes. If your test reveals that the dynamo is indeed generating, then the next place to look is the cut out.

People get confused with these cut outs because the two coils are mounted separately, but electrically the thing functions as a normal reverse current relay -just like modern ones. Testing with a screwdriver blade and with the dynamo producing 12-15 volts, there should be appreciable magnetic drag on the ends of the fine wire coil. If there is no magnetic drag, then check the dynamo voltage at the cut out terminals and also check the earth terminal. The fine wire coil is shunted across the dynamo and the return path is to earth via the terminal marked 'B2-' (earth on 12v set).

\*(This is effectively earthed on the negative side of the second battery via the terminal 'B2-' on the solenoid switch. This is to prevent the cut out pulling in when you apply the full 24 volts for starting purposes. The potential difference applied to the cut out under these conditions is only the voltage of the second battery which, under starting conditions would not be any more than 9 or 10 volts, insufficient to pull the cut out in - cunning!). Sometimes you find loose connections in the cut outs which make high resistances. They are, however, very robust and it is rare to have one burn out. Once you have this coil working then the unit must function, provided the spring tension is okay. With the engine speeding up gradually, the cut out should pull in at about 12-13 volts and drop out again at about 11 volts. When it is working correctly very little arcing should be observed as the points make and break.

I am assuming you have a wiring diagram and have checked that all the connections are tight etc. Don't forget that the charging current comes up the heavy main cable to the solenoid switch terminal No. 5, (starter switch on 12v sets) and there should be a secondary lightweight wire from this terminal to the cut out.

## The Solenoid

### Description

The Rotax SOL/CT3 instrument is unique to the large engined Talbot cars. Its purpose is to allow the application of 24 volts for starting and 12 volts for charging. In doing so it fulfils three distinct functions :-

- (1) It acts as a change over switch connecting the two batteries in series for 24v starting and then putting them back to parallel for 12v charging.
- (2) It acts as a solenoid transmitting upwards of 500amps from the series connected batteries to the dynamotor for starting. This is done by means of a pair of very heavy duty copper contacts.
- (3) It transmits the precious 10 amps of charging current to the two parallel connected batteries. This is done by means of a separate pair of charging contacts.

A full description of the working of the solenoid and its relationship with the other parts of the electrical circuit is contained in the article from the "Automobile Electricity" magazine of June 1934.

It is mounted between the front of the battery carrier and the engine and little can be done on the unit in situ other than check the tightness of the cables. Poor connections are a frequent source of lethargic starting. Don't go anywhere near the unit with a metal spanner unless the batteries are disconnected. It is highly recommended to fit two isolator switches to the earth side of the batteries.

### On the Bench

Any repair work on this unit is best left to the experts. If you ever have to remove it the **most** critical thing is to ensure that the wires go to the correct terminals. Each terminal is clearly marked and should be connected as follows :-

Terminal 5: To the dynamotor and lighter wire to the fuse box.

Terminal B2- : To negative terminal on front battery and lighter wire to cut out

Terminal B2+ : To positive terminal on front battery

Terminal 6 : To positive terminal on rear battery and lighter wire to ammeter

Sol : To starter contact in the cut out

A modern American Delco unit is now available as an alternative to the 80+ year old Rotax SOL/CT3. They are similar in size and work in an identical manner. Full details are given later in this section.



How it looks on the car. Note connections carefully



How it looks on the bench



All terminals are marked but not always as clearly as this



Solenoid terminal on left. Earth on right. Make sure both are tight



## The Fuse Box

### Description

The fuse box is the larger and lower of the two boxes mounted on the nearside bulkhead. All electrical circuits run through here with wires feeding in from the armoured conduit. The fuse box cover contains spare fuses and a useful colour coding for the wiring.



The cut out above and fuse box below



Inside the fuse box lid. Note spare fuses

### Maintenance

There is no maintenance required other than checking terminal connections are tight. The critical fuses for charging are the field fuse 7 (vertically mounted 20amps) and the main fuse 5 (horizontally mounted 30 amps.) If there is no charge check these fuses for continuity and make sure the fuse holders are clean and grip tightly. The main fuse in particular transmits a high current.

The fuse box contains a hidden secret. The field terminal (7) and main terminal (5) are connected by a brass strip on the back of the fuse box. After 80+ years of vibration the rivets can work loose and cause a lack of charging. Unfortunately the only way to access this connection is to undo all the wiring and remove the fuse box. Whilst this is not technically difficult it demands great attention to detail to ensure all the wires go back in the right place. A temporary fix is to connect the field and main fuse holders together with a stout piece of wire. This will also aid your diagnosis.



Field fuse is vertical



Main fuse is horizontal

## The Cut Out

### Description

The cut out is the smaller and higher of the two boxes on the nearside scuttle. It is a twin coil reverse current relay that isolates the dynamotor from the battery when output voltage is below 12v and connects the two when it is above 12v. Without it the battery would quickly drain away through the dynamotor. It does its job by means of moving contact points, which are set to close when the dynamotor revolutions rise beyond 850rpm and output voltage is above 12.5v.

### Maintenance

There is little maintenance to be done on this unit, other than cleaning the contact points from time to time with a fine emery board. Any malfunctions are best tested and repaired by an auto electrician. If you are tempted to fiddle, make sure you turn the batteries off. Any closure of the points when insufficient voltage is being generated by the dynamotor will instantly blow the main fuse.



The twin coil relay. Charging contacts on the left, solenoid on the right

Before we leave the cut out it is important to understand the role it plays in the starting circuit for the 12/24V cars. In principle the electrical circuit follows normal practice, with a light current from the battery going via the starting switch to the solenoid. This current activates the solenoid coil, closing the heavy duty contacts which allow current to flow to the starter motor – in the case of the Talbot up to 500amps!

But being a Talbot the practice is not quite so simple. The complexity arises from the 12/24V set up. It builds in a safety feature that prevents accidental operation of the starter button sending 24V down the wire to the dynamotor circuit, whilst it is generating and sending 12V back the other way. It works by means of a second contact in the control box – being the one on the left in the picture above which isolates the solenoid when the engine is charging.

To understand its working you need to trace the flow of current shown in the diagram below.

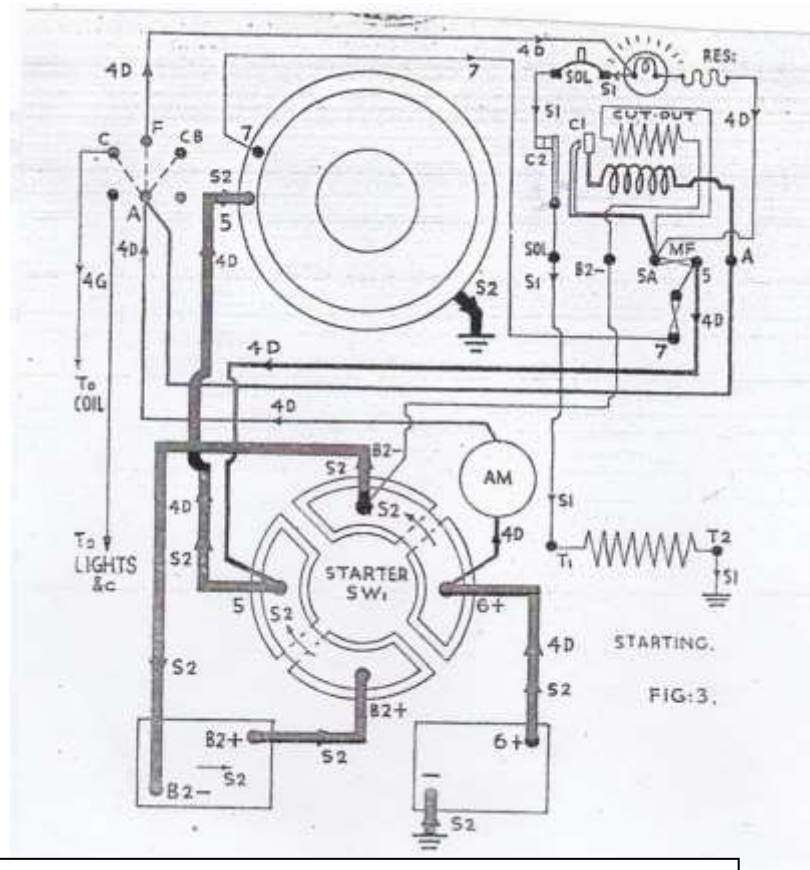

The Talbot 12/24v starting circuit

Current flows from the positive terminal of the back battery to terminal 6 on the rearward face of the solenoid. From here a separate wire takes current to the ammeter and thence to the ignition switch. When that switch is placed in the on position current flows down one circuit to the coil and down another to the ignition light. From the input side of the ignition light a wire (green) spurs off to the starter switch on the dashboard. So far so normal.

When the starter switch is depressed the current flows to the middle terminal of the cut out box. Here it connects to a solid copper wire that sneaks behind the cut out coils and attaches to the fixed side of the starting circuit contact. At rest this touches the moving contact, through the application of spring pressure. Current flows through the moving contact arm and via a flexible copper braid and solid copper wire to the SOL terminal on the cutout box (fifth from the right). Here it meets a wire connected to terminal T1 on the front end of the solenoid casing. Current flowing through this terminal activates the solenoid coil, throwing forward the armature and connecting the two batteries in series. Thus 24V is able to start the beast! Once the dynamotor is generating more than 12V (about 900rpm) the charging contact closes and makes the charging circuit. This has the effect of opening the starting contact and disabling the starting circuit. Hence the in built safety feature.

So if the application of your thumb produces nothing but the sounds of silence get the test light out and systematically trace round the 12 foot of wiring and 16 connections for electrical continuity. Pay particular attention to the cut out box, its terminals, moving contact and flexible braid.

## The Dash Board

### Description

The dashboard is conventionally wired. All switches and gauges are housed in a fixed steel box. To reach these remove the protruding knobs (light switch, wiper, starter etc.). Then remove the four wing nuts from the back of the steel box and lift off the front panel.

### Maintenance

There are no particular maintenance requirements. The charging/starting circuits involve ammeter, ignition switch and starter switch. These are accessed by removing the front panel and tested in a conventional manner.

As originally wired the 14 and 18hp cars have the heavy duty battery cables running to the starter switch. This adds unnecessary resistance to the starting circuit as well as subjecting an 80 year old switch to hundreds of amps. Better to install a modern solenoid near the battery and use the dashboard switch for the low activating current.

### Charging Control

The principle drawback of the vintage three charging system is that it produces constant current from the dynamo, irrespective of whether the battery needs charging or not. It is important to get some control over the charging rate to avoid overfilled batteries which, in the most extreme cases, can explode. The smaller cars have a “half charge” resistor wired into the dynamotor. The larger cars dispense with this, relying on the two batteries to mop up the 12 amps equally. This doesn't always happen and one battery often gets the lions share, exacerbating the overcharging problem. You are strongly advised to read the body of Talbot literature on this subject and incorporate a switch or resistance device to the field circuit to avoid battery problems. The TOC now produce an excellent dynamotor charge regulator. This has been tested over many thousands of miles. A full description and fitting instructions are included later in the section.

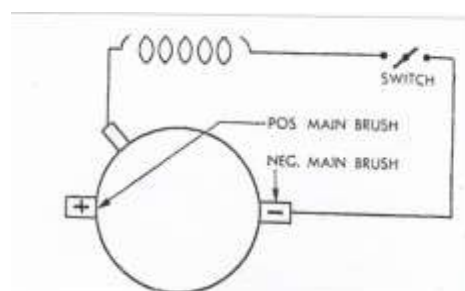

Wiring a simple on-off switch

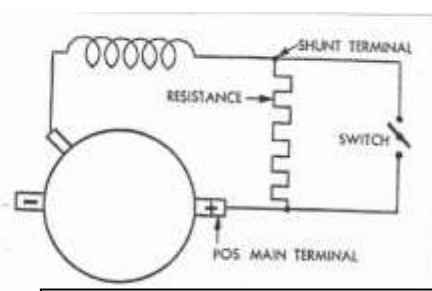

Wiring a half charge resistance giving two charging rates

## Replacing the Talbot Rotax 12/24v Changeover Solenoid by the Delco 1119844.

### 1. Check that the switch is a 12/24 volt DC Series Parallel Switch Triple Stage Type.

- Using a meter and Diagram 1, check there are connections between terminals 1 and 3 and also between terminals 2 and 5. Terminals 6 and 7 connect to the operating coil which has a resistance of about 2 ohms. Check there are no other connections.
- Using Diagram 2 as a guide, connect the positive terminal of a 12v battery to terminal 7 and the negative terminal to terminal 6. The switch should operate with a loud click.
- While the switch is energised (note duty cycle is 90 seconds ON, 6 minutes OFF), check there are connections between terminals 1 and 2 and between terminals 3 and 4. Check there are no other connections.

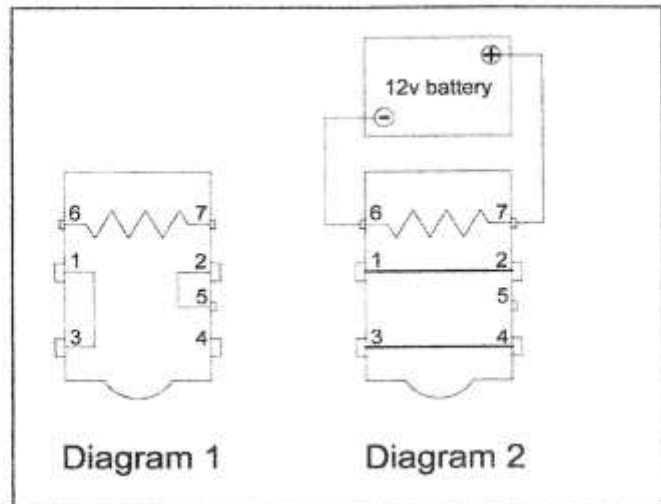

### 2. Identifying your leads.

- Diagram 3 shows the original wiring diagram for the Rotax solenoid switch. Use this to identify your various leads.
- The table shows the corresponding labelling of the leads for the two switches.

Rotax Solenoid	B2+	B2-	5	6	Sol	Earth	Earth
Delco Solenoid	3	2	4	1	7	6	5

### 3. Installing the switch.

- Disconnect the battery leads at the batteries and remove the Rotax switch. Disconnect the main lead at terminal 5 on the dynamotor.
- Wire up the switch as shown in Diagram 4, leaving the dynamotor disconnected. Ensure the connections at 3 & 4 can't touch the metal end cap. The Delco switch needs two earth leads connected to terminals 5 and 6. (The Rotax unit earthed through the body of the switch.) Use good sized wire (25 amp) for these earths.
- Replace the battery leads at the batteries, leaving the bolts loose if you don't have master switches fitted in case you want to remove the leads in a hurry. Don't reconnect the dynamotor.
- Check you get a nominal 12 volts at terminals 1 & 3 and 0 volts at terminals 2 & 5. Check your lights work. Switch on the ignition and check that the ignition light comes on.
- Press the starter switch with the ignition on. The Delco switch should operate with a loud click.
- Check you get a nominal 12 volts at terminals 1 & 2 and a nominal 24 volts at terminals 3 & 4 while the starter switch is pressed.
- Do up the battery lead bolts. Connect up the main lead at terminal 5 on the dynamotor.
- The car should now start!

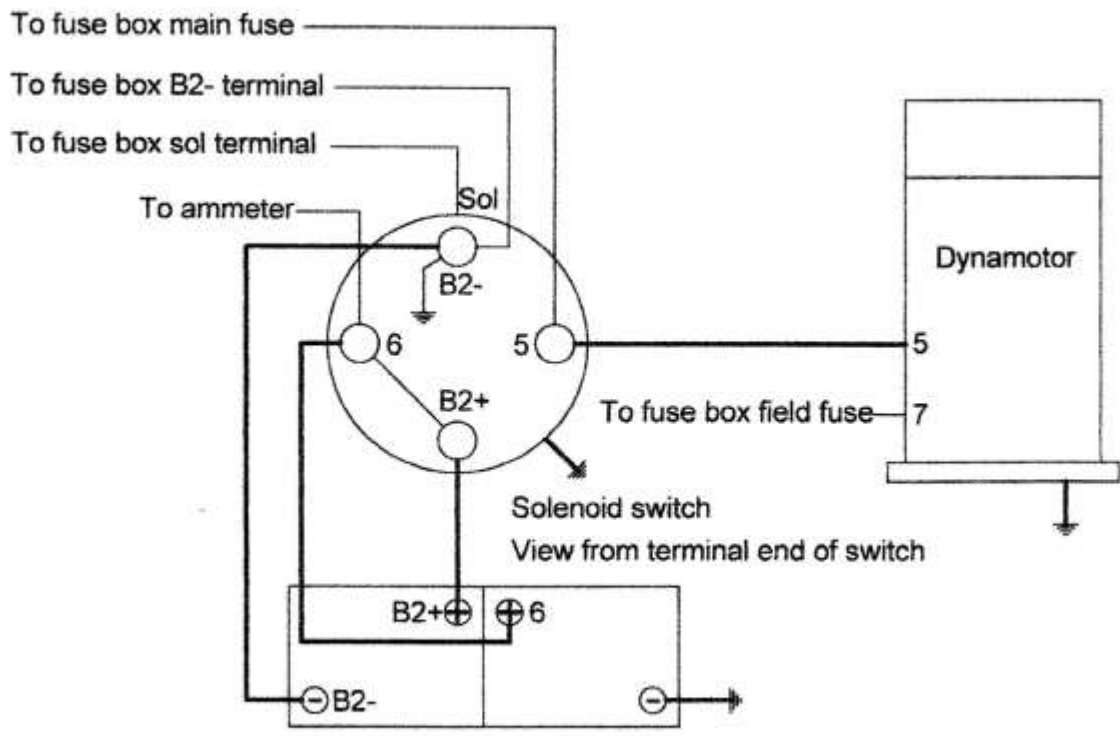

Rotax solenoid OFF (normal running)

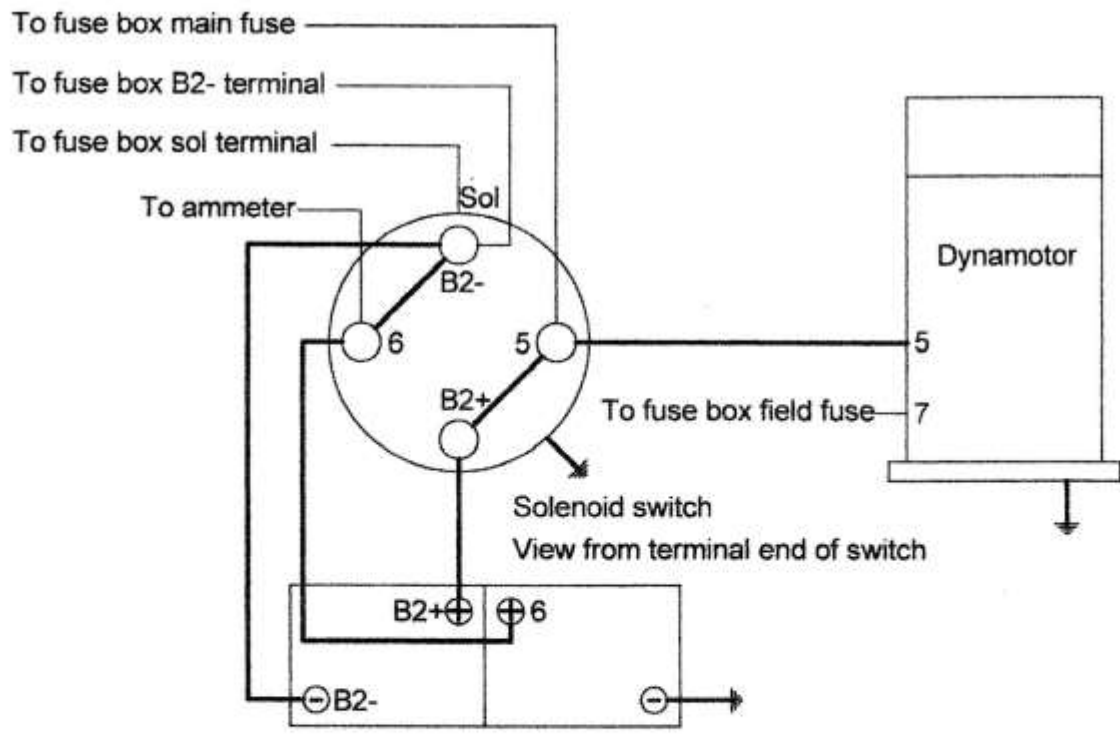

Rotax solenoid ON (starting)

**Diagram 3**

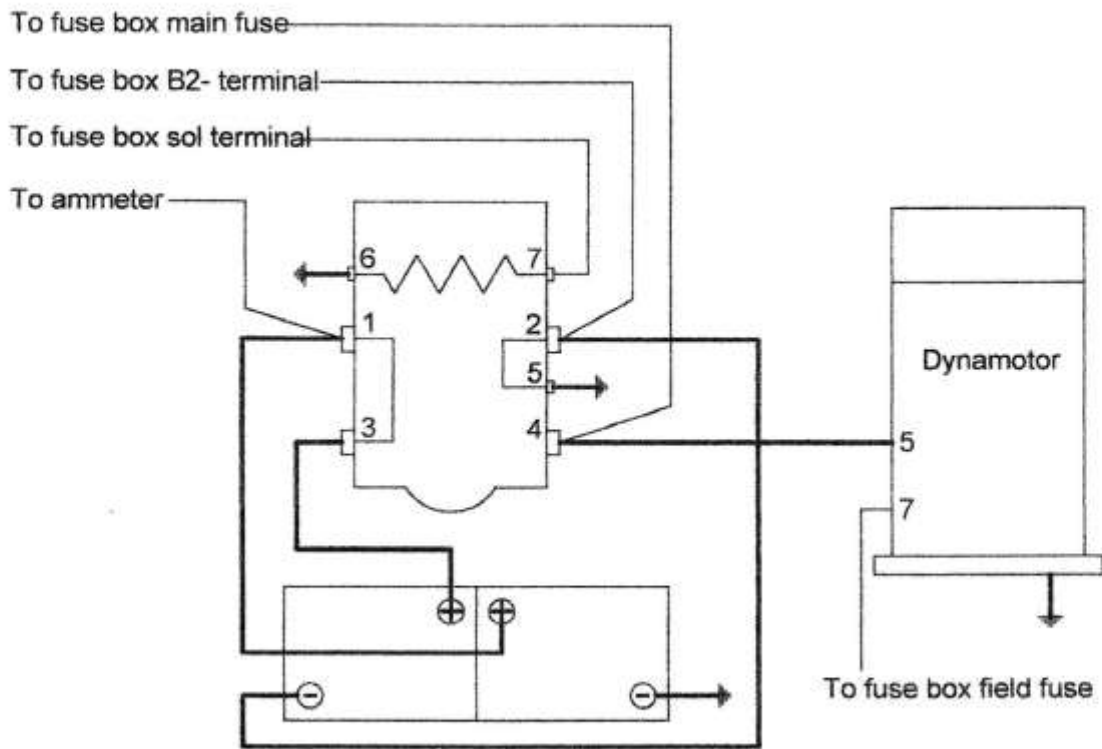

Delco solenoid OFF (normal running)

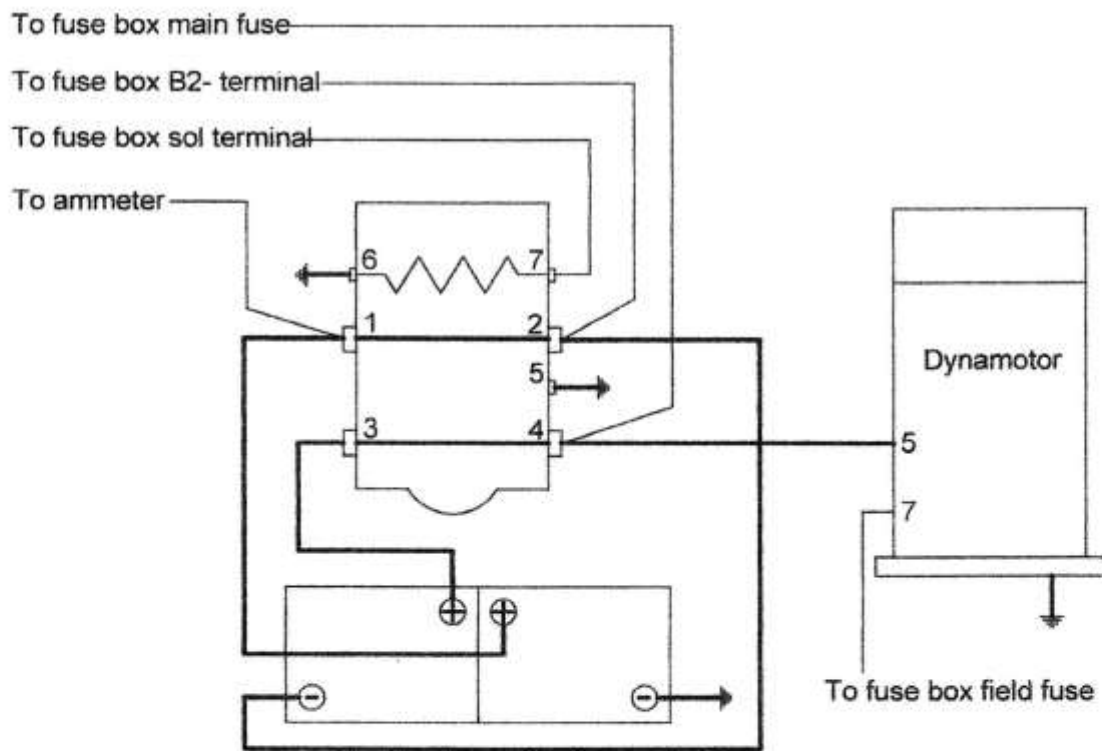

Delco solenoid ON (starting)

**Diagram 4**

DRAFT by IAP 20<sup>th</sup> January 2012

Replacing the Talbot Rotax 12/24v Changeover Solenoid by the Delco 1119844.

The image below is at [www.texasindustrial.com/relays.asp](http://www.texasindustrial.com/relays.asp)

It is about 7/8<sup>th</sup> of the way down the page.

Apparently it was used on B series Mack trucks in the sixties.

### 12/24 Volt DC Series Parallel Switch Triple Stage Type.



Replaces Delco 1119844 (9-844)

In some applications it will replace the Leece Neville 5155S

12 Volt DC Series Parallel Switch

12/24 Volt Series Parallel Solenoid Switch

Voltage: 12/24V DC

Intermittent duty Cycle

Triple Stage, 3 Collar

Contacts: **Silver**

Flat Base type bracket Large studs: 3/8"16

Coil terminals: 10-32 Studs

[Click Here Or On Relay For Typical Wiring Diagram](#)



## Installation Instructions for the Talbot Dynamotor Regulator Mk 4

The Mk 4 has the same box and the same colour coded wires as the Mk 1 so changing from Mk 1 to Mk 4 is straightforward, however note that the anti-spike additions provided for the Mk 1 are **not** needed as they are built into the Mk 4.

**Disconnect your battery before starting work!**

**Check the field fuse is correct** (15A on 14/45, 20A on 12V starting systems and 25A on 24V starting systems.)

**The field fuse is important as it protects an expensive dynamotor. The fuse MUST be positioned in the circuit as shown in the diagrams.**

**The unit is suitable for all Talbots with a dynamotor.** The same unit works with either 12v or 24v starting systems. No alterations are made to the dynamotor; the third brush still controls the maximum current.

**Do ensure your ignition is suppressed by using resistive plug caps or resistor plugs.** Tests have shown 200 volt spikes with unsuppressed ignition.

### Positioning the unit.

Heat is the enemy of electronics so mounting it on the engine side of the bulkhead is not the best solution, though units have been mounted there with no problems.

I think the best place to mount it is under the front apron near the dynamotor, sheltering inside the front cross member (see picture). No wires need to be disconnected in the fuse box, the unit keeps cool, there is plenty of room to install it, the under bonnet view is unchanged and it is easy to change back to normal charging if the unit fails.

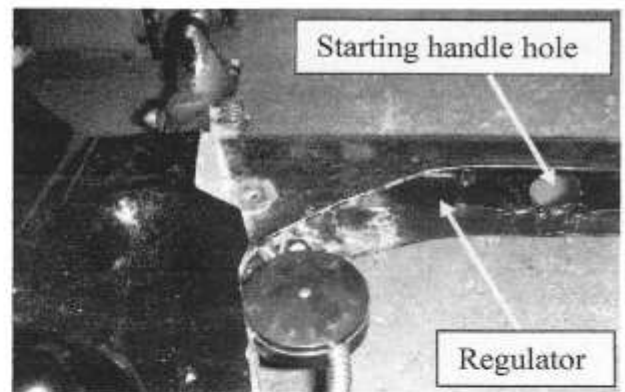

### Wiring.

Use wire with a current capacity of around 15A. This size is not needed for the 12v line, which only takes 20 mA, so a thinner cable could be used here. A wiring diagram is shown on page 3.

### Unit positioned alongside the dynamotor.

Disconnect the wire from the dynamotor field terminal (7) and connect it to the blue wire. Connect the yellow wire to the dynamotor field terminal. Connect the red wire to your chosen 12v connection, and the black wire to a good earth.

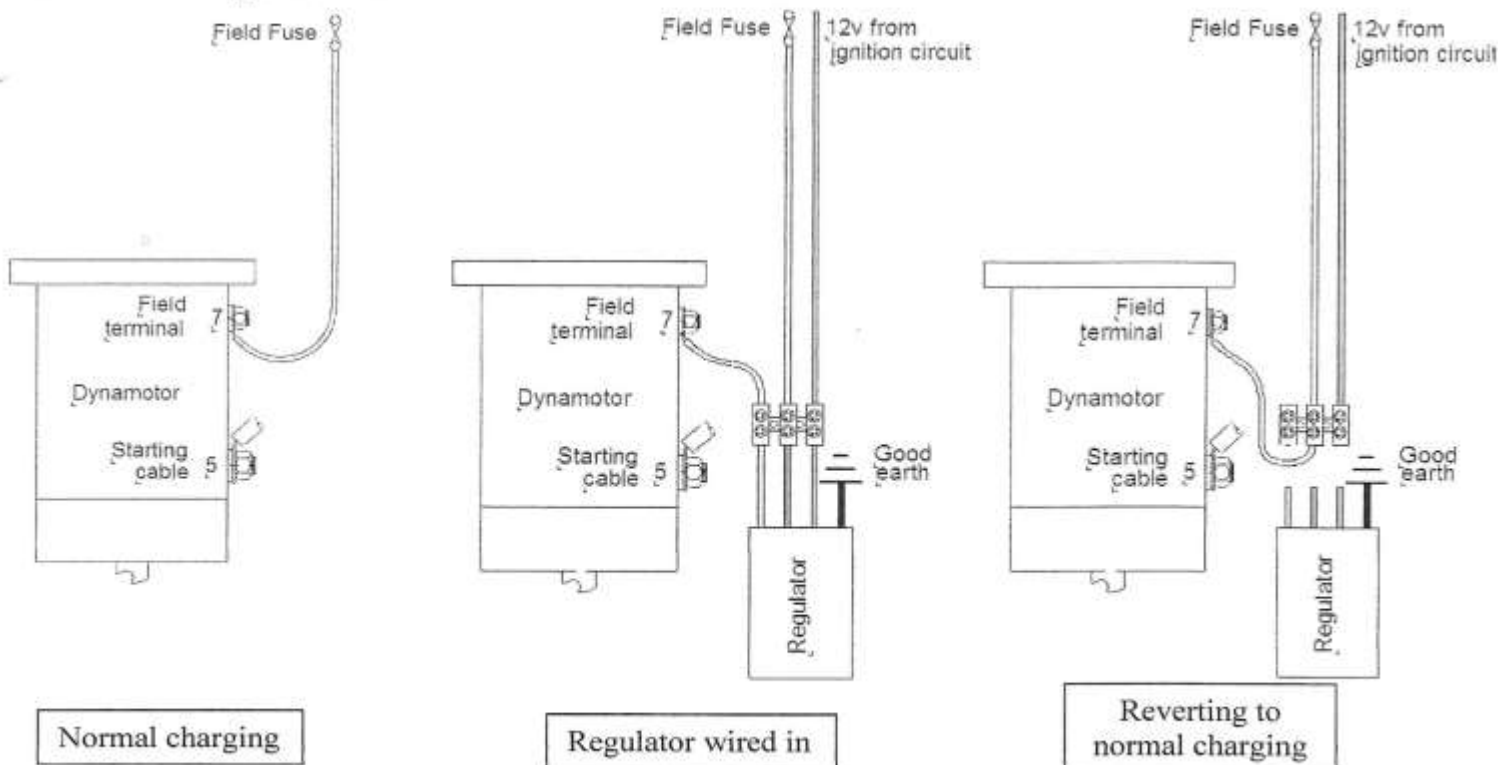

### Unit positioned near fuse box.

Disconnect the wire marked 7 from the bottom of the field fuse and check that this wire does actually come from the field terminal on the dynamotor. Connect it to the yellow wire.

Connect the blue wire to the bottom of the field fuse. Connect the red wire to your chosen 12v connection, and the black wire to a good earth.

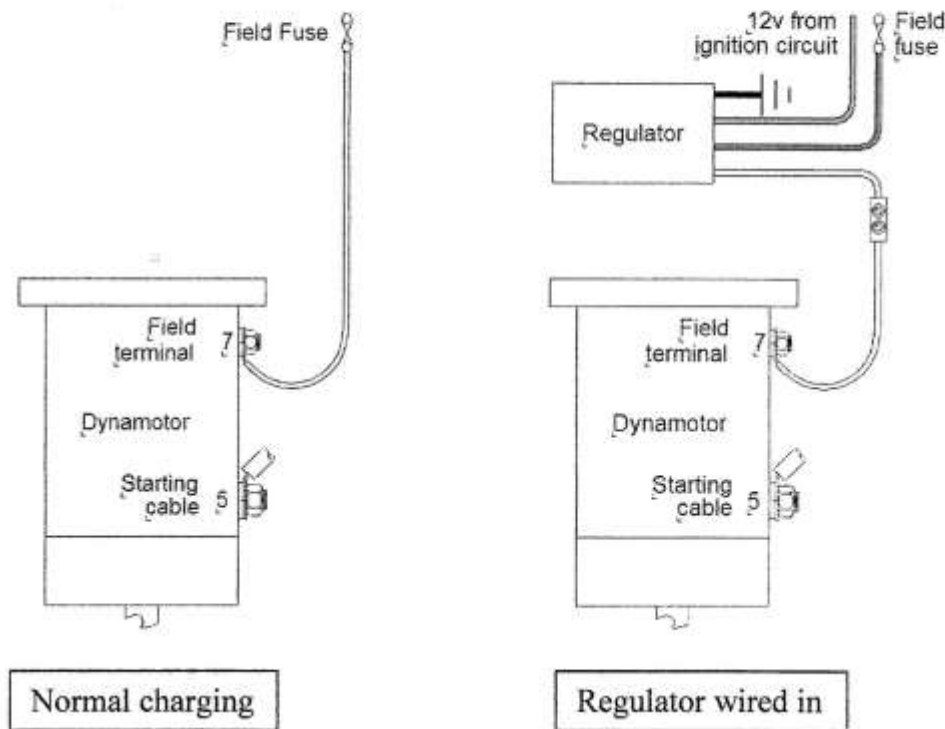

**Before reconnecting the battery, double check that the connections are correct.**

If the unit is connected incorrectly it will fail when you switch on and you will need a new unit.

### Finding the wires.

The diagrams on the last page show some typical junction boxes with the field fuse shown in blue.

The green lines show hidden connections behind the board. These can give trouble – one of mine only gave an intermittent connection leading to charging problems – so check yours.

The 12V connection should be switched via the ignition switch. Red dots show 12v connections switched by the ignition switch. Check the one you decide to use does switch on and off with the ignition switch in case your wiring is non-standard (use a voltmeter or a bulb.)

Black dots show earth connections – again check it really is one. The earth needs to be a good connection capable of taking 10A. If in doubt run an earth lead to the chassis or battery.

### What to expect.

After starting, the ammeter should show maximum charge for a minute or two before gradually dropping down to a trickle charge of around 1A. If your battery was undercharged to start with then the maximum charge could continue for much longer.

If you switch your lights on the unit will respond immediately. Your ammeter will show either a small discharge if your maximum charging rate does not balance the load, or a small charge if your maximum charging rate exceeds the load.

The maximum charge is still controlled by the third brush and can be altered in the usual way.

If you have a half charge switch, run in the maximum charge position all the time. Using the half charge position will not harm the unit, but will result in the battery taking longer to charge.

If you can turn the charging off, don't. Turning the charging off will not harm the unit, but is unnecessary as the unit will not allow the battery to become overcharged.

### For the curious.

If you take the lid off the unit, all you will see is two LEDs and an adjustment screw. The adjustment screw controls the maximum voltage (see below). The red LED turns on when power is connected. The green LED is on when the unit is regulating and off when the unit is not regulating.

### If the unit does not work.

Take the lid off the unit.

Check the red LED comes on when you switch on the ignition. If it doesn't then the unit is not getting power via the ignition switch, or your earth is faulty.

When you switch on, as well as the red LED coming on, the green LED should briefly flash on and then go off. If it doesn't, contact Ian Potts.

### Voltage setting.

The maximum charging voltage has been set at 14 volts. This can be altered (see below).

The table below shows the voltage at which gassing occurs in the battery:

Temperature °C	0	10	20	30	40
Gassing voltage	15.24	14.82	14.5	14.19	14

The higher the voltage, the quicker the battery is charged, but the closer one comes to the gassing voltage. I decided 14 volts was a good compromise, and in practice the battery is charged quickly. If you are motoring where temperatures are higher than 40 °C then the charging voltage should be reduced.

### Changing the voltage setting.

Make sure the battery is fully charged. Connect a voltmeter across the battery. (I plug a voltmeter into the inspection lamp sockets on the dashboard). Take the lid off the unit to gain access to the adjustment screw. With the dynamotor charging (engine speed around 1500 rpm), adjust the screw in the unit to give the desired voltage. Each turn changes the voltage by about 0.2 volts. Turning the screw clockwise reduces the voltage, turning it anti-clockwise increases the voltage. Keep a count of the number of turns you make so you can return to the original setting.

(If you have a preselector box, it is best not to rev the engine in neutral. Connect the voltmeter so that an assistant can read it while you drive.)

### Changeover switch.

It is possible to wire in a changeover switch to switch between regulated charging and the normal three brush set-up, useful if the unit ever fails. The circuit diagram for this is shown below. Diagram 1 is normal charging, Diagram 2 shows the regulator wired in, Diagram 3 shows a changeover switch wired in.

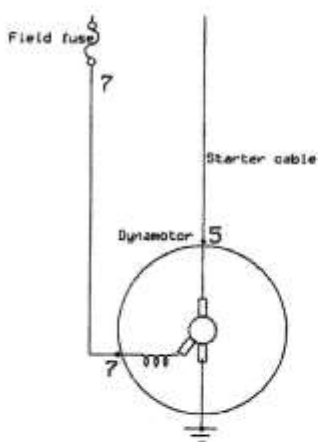

Diagram 1

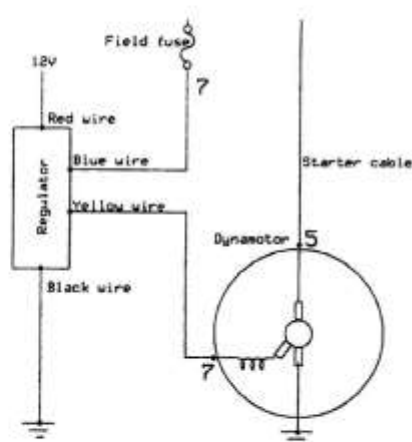

Diagram 2

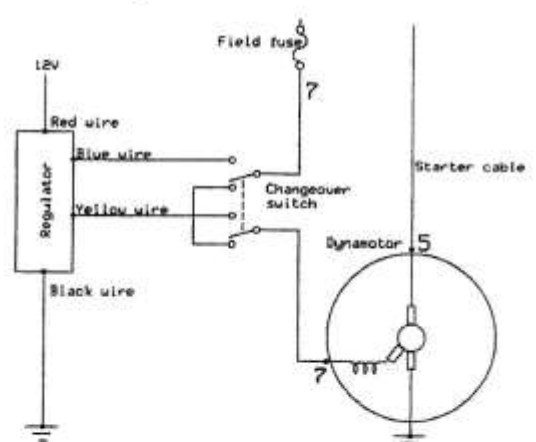
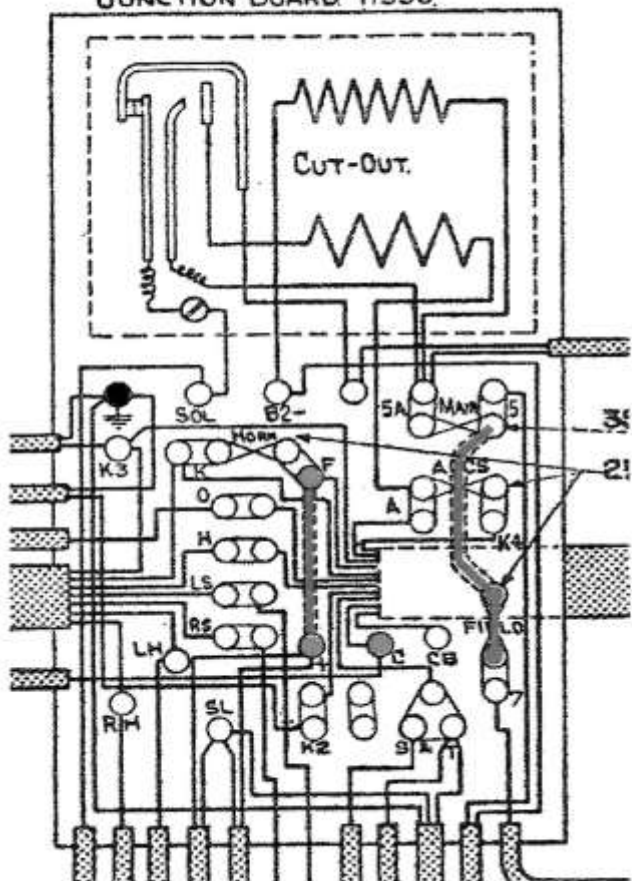

Diagram 3

I.A.Potts. 8<sup>th</sup> March 2015.

JUNCTION BOARD 11930



Typical junction box for 24v starting

JUNCTION BOARD - 11960/2

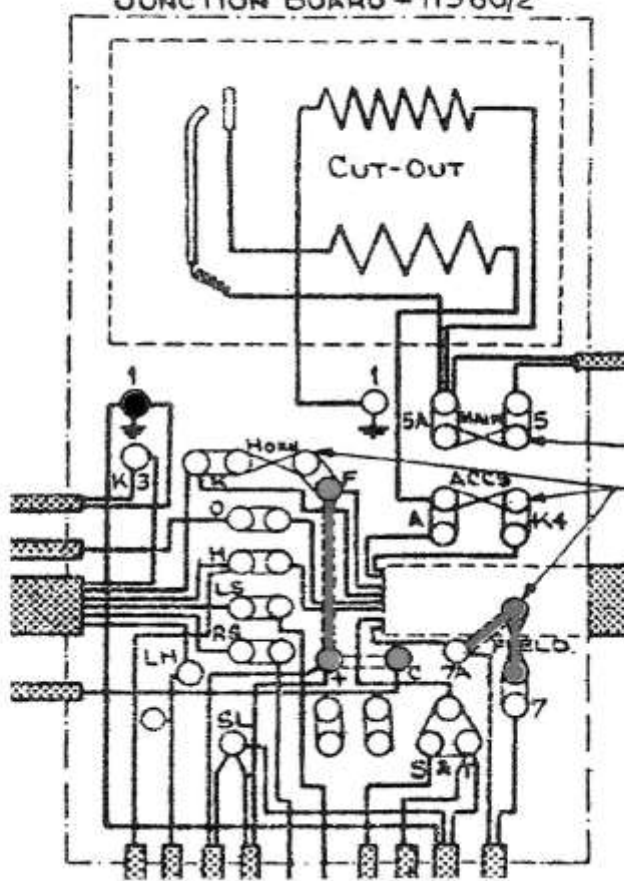

Typical junction box with half charge facility

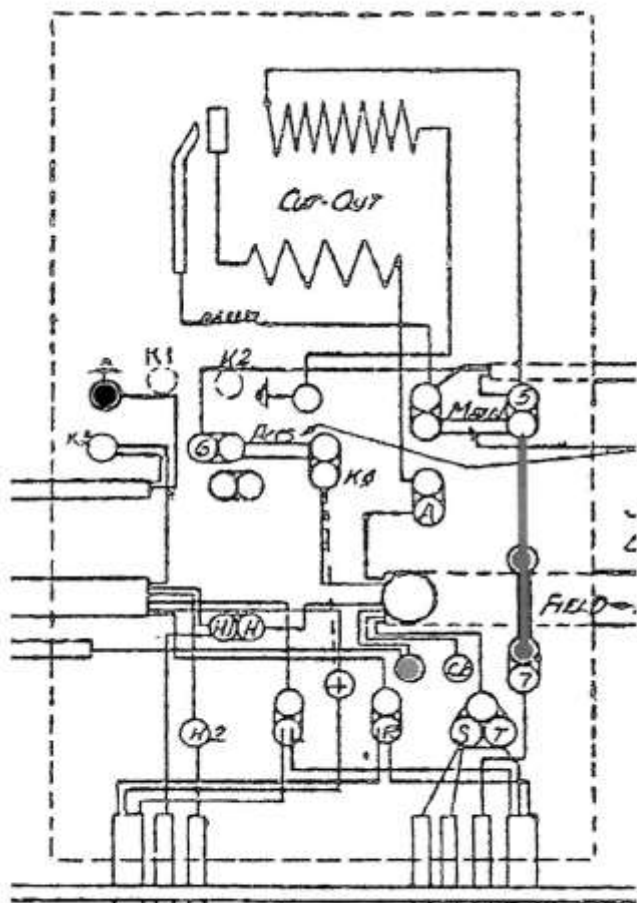

Junction box early 75 and 90

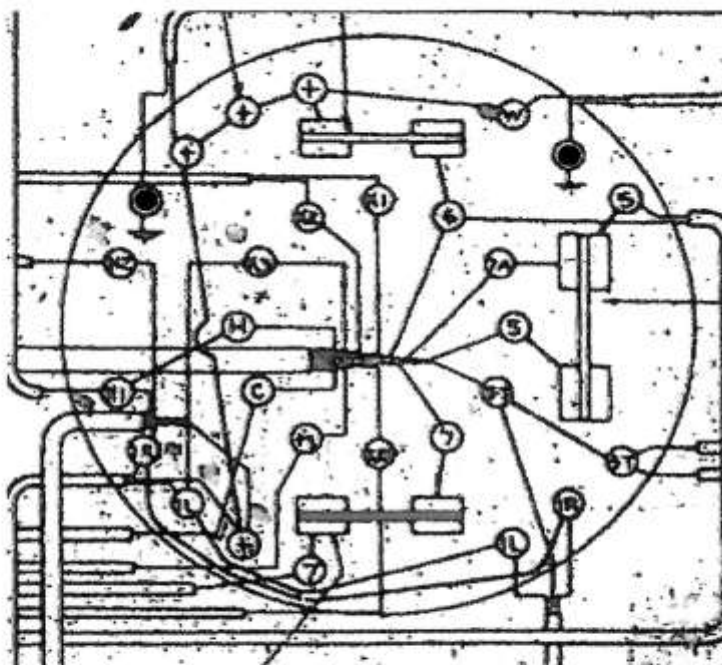

Junction box 14/45

# About This Month's Diagram

**T**HE AUTOMOBILE ELECTRICITY Wiring Diagram D.311 published with this issue should prove particularly interesting because it includes the connections of the Rotax 12 volt charging and 24 volt starting dynamotor, together with those of the special cutout and change-over switch used therewith. This dynamotor is known as the type B.M.9, and is fitted as standard to 1934 Talbot "95" and "105" cars, functioning in conjunction with two 12 volt batteries under single pole operation, and, whether driving or being driven, is directly coupled to the front end of the engine crankshaft.

Further, while it is of orthodox design its construction is exceptionally robust, and the brush gear is such that the positions of the main brushes and the "third brush" can be adjusted to a degree giving the very best results.

### Advantages of System

Since the dynamotor is directly coupled, the advantage of 24 volt operation when starting will be readily appreciated, particularly in the cold winter months, while the advantage of 12 volt charging and consequent lighting lies in the direction of standard lamp bulbs, better lamp focus, and short and strong lamp filaments. In order, therefore, to obtain the alternative voltage operation for starting and charging a special automatic change-over switch is necessary.

This switch is illustrated in Fig. 1, where H1 is a bracketed and flanged cylindrical aluminium casting housing the switch contacts, and G a flanged intervening piece of pressed steel located between the flange of housing H1 and the flange of housing H2. Housing H2 is of pressed steel and contains the energising coil C, Fig. 2, for the solenoid operation of the moving starter switch contact SS,

## Rotax 12 Volt Charging and 24 Volt Starting Dynamotor

while externally its rear surface serves as a mounting for the "live" and "earth" terminals t1 and t2 respectively of the coil.

### The Change-over Switch

The coil is a most sturdy job, being about 3 in. in diameter and wound about a brass spool with a core hole of 1 in. Within the latter slides the iron core piece CP, and attached to the core piece is a brass forward extension which receives centralisation from the intervening piece G. The intervening piece also serves to

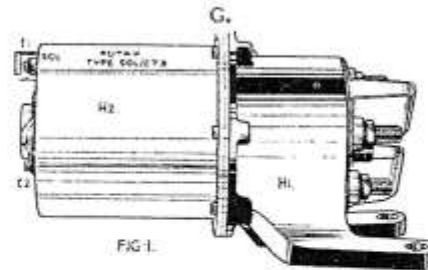

FIG. 1.

prevent the core piece and its extension from turning, for the male and female fit as between the two members is square.

Further, the centralising extension x of the intervening piece, in sinking into the core hole of the spool when the whole is assembled, localises the magnetic flux arising from the coil in the region of the leading end of the core piece, and thus facilitates sure and rapid action thereof.

It will be observed that the brass extension of the core piece is fashioned in three sizes. Of these sizes the largest—as indicated by the cross-hatching—is square in section and acts as centraliser and locater as previously explained. The intermediate size i follows the section of a rectangle with rounded ends, and

engages with the ebonite base eb1 of the moving starter-switch contact SS. The smallest size s follows the same section as that of intermediate size, but being smaller it engages with the moving contact CS of the charging change-over switch.

Like the rest of the job it will be seen that the starter switch contacts—moving and stationary—are of most robust construction and excellent in design. For instance, the diameter of the moving contact is about 2½ inches, while in thickness it measures ¼ inch. The ebonite base follows similar proportions, and is, therefore, well able to carry the four radially disposed screws supporting the two-part contact, which, by the way, is spring loaded under four independent springs wound about the respective screws and located between the contact and the base.

Hence, with the rightward movement of the base, the two-part contact is made to bear against the stationary four-part contact FC, perfect contact between the two members being assured by the universally flexing nature of the former in consequence of spring loading.

In thickness the stationary contacts measure 7/16 inch, and it is important to note that to three of them, B2+, B2-, and 6, three respective contact tongue pieces are attached. The tongue pieces extend radially inwards, and, under charging conditions contact with a two-part moving contact CS constituting the charging change-over switch, and which is held against them under tension from the compression spring A located between the right hand side of the contact and the base of the housing H1. Moreover, one part e of the moving two-part charging contact is permanently earthed to the housing H1 by a short internal lead.

For the rest as regards switch

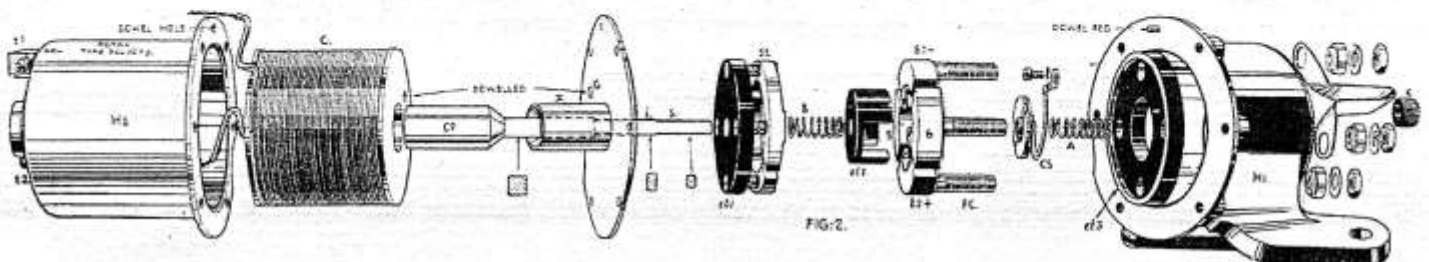

FIG. 2.

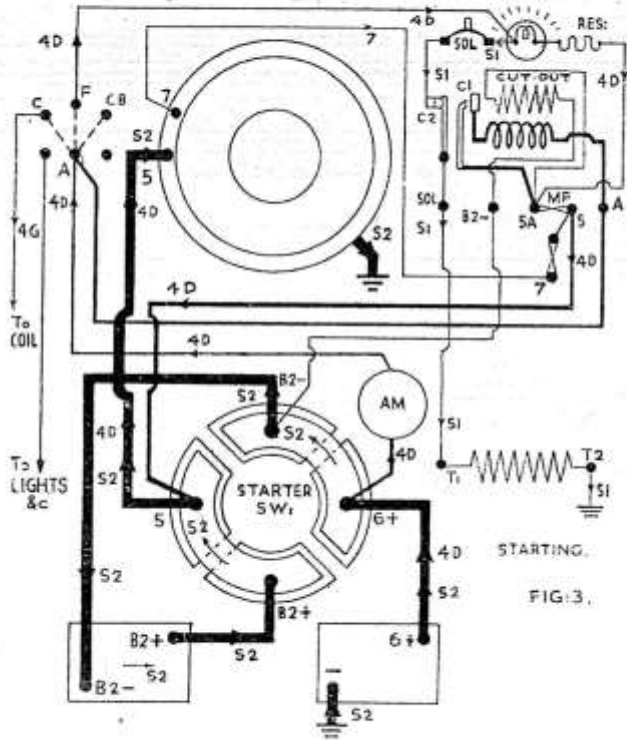

FIG. 3.

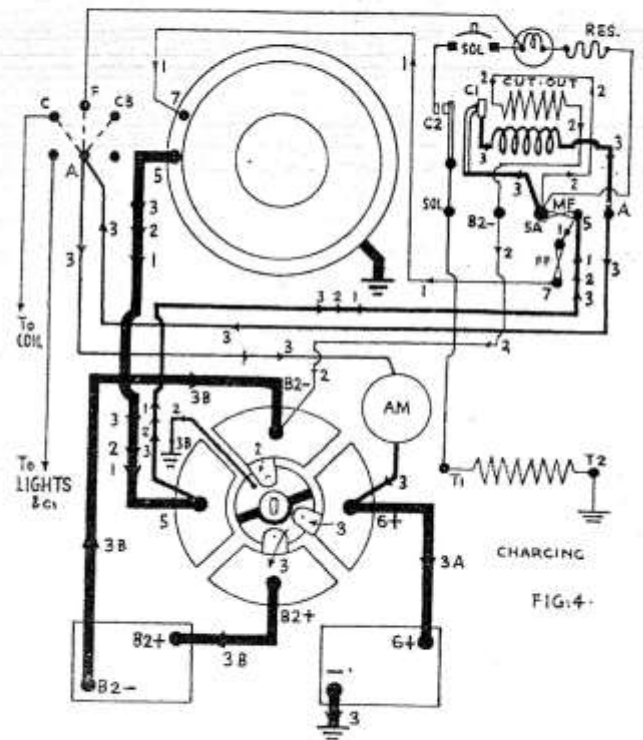

FIG. 4.

construction the ebonite piece eb2 serves as a platform for the compression spring B, which normally keeps the two-part starter switch contact SS out of contact, the ebonite piece eb3 serves as an insulated mounting for the four-part starter switch contact FC, and the knurled knob K constitutes an adjustable stop for the energised endwise movement of the solenoid core, C.P.

**The Special Cutout**

Regarding the cutout, this unit, while following the orthodox design of the Rotax type 11570 unit, is provided with an additional pair of contacts, which, under charging conditions, break the operating circuit of the coil C actuating the automatic change-over switch. There can, therefore, be no accidental operation of the starter-switch while the engine is running, and consequently no possibility of 24 volts being applied to cutout or dynamo windings.

Furthermore, even if operation of starter-switch were possible while the engine was running, the lamps and the cutout could not suffer damage since the circuits for these units are wired in such a way that under the conditions mentioned but 12 volts would be applied to them.

**Starting the Engine**

However, in considering the operation of the whole and assuming the engine is idle and about to be started,

the first action will be for one to place the combined lighting and ignition switch in its third position. This position places the ignition, the ignition warning discharge light, the oil pressure indicator, the horn, and all other accessories in circuit. It also causes the starter-switch operating press-button to be placed in circuit, and since the cutout is devoid of energisation the extra cutout contacts C2, D311, will be closed.

If therefore, the starter-switch operating press-button SOL is depressed the coil C, Fig. 2, will become energised, and consequently the core-piece CP will be made to move to the right and in so doing carry both the two-part moving starter-switch contact SS and the two-part moving charging-switch contact CS with it. Hence, while the moving starter-switch contact is made to contact with the stationary starter-switch contact FC, the moving charging-switch contact is made to break contact with the radial tongue pieces affixed thereto. Moreover, it will be seen that the stationary starter-switch contacts 5 and B2+, and 6 and B2-, Fig. 3, are respectively bridged in pairs by the eclipsing starter-switch contact, so that the two batteries become connected in series with the dynamotor which accordingly operates on 24 volts as a starter.

**Starting and Ignition Circuits**

Referring to Fig. 3, the 24 volt starting circuit, circuit S2, will be as from battery terminal 6+ to stationary starter-switch contact 6 to stationary starter-switch contact B2- via a moving starter-switch contact, to battery terminal B2- to battery terminal B2+ to stationary starter-switch contact B2+ to stationary starter-switch contact 5 via the second moving starter-switch contact, to dynamotor terminal 5, through the machine to earth, and so back to battery terminal-.

While this circuit operates under 24 volts, however, the main discharge circuit, circuit 4D for ignition, warning lamp, starter-switch operating coil and lights, etc., operates upon 12 volts since it is fed from the stationary starter-switch contact 6 and returns via earth to negative terminal of the battery feeding stationary contact 6.

Tracing the path of this circuit it will be found that battery terminal 6+ is connected to the terminal A of the combined lighting and ignition switch via stationary contact 6 and the ammeter, and that at the lighting switch the circuit divides into two parallel paths, one, 4G, for the ignition coil and contact breaker circuit, the other, 4D, continuing from contact F to the warning lamp, on the feed side

(Continued on page 178)

# Why a Third Terminal?

## A Master Switch Query

WE are asked at various times why a third terminal in addition to the two required to open the main battery circuit is required in the usual type of master switch now fitted. Alternatively, enquirers are sometimes in doubt why an extra wire is added to one of the ignition coil terminals, more particularly as on isolated occasions it has been found that a start cannot be obtained until this additional wire has been disconnected. At first glance the reason does appear to be rather obscure, but the explanation is quite simple.

### No "Off" Position

It is the practice with many cars to fit a permanent charge dynamo, that is to say, a machine which has no off position in a literal sense, the switch positions being "Summer" and "Winter," and giving two different output figures, with a possible further increased output with the switch on "Lamps." There is, then, no means by which the engine can ordinarily be run without the dynamo field being completed either through a reduced charge resistance or on maximum output. It will be understood that if, with the engine running, the master switch is put at "off," i.e., battery feed open, and the circuit from the battery to coil accordingly interrupted, the engine will continue to run because the coil current will be supplied direct by the dynamo. The latter being run on an open battery circuit will blow the fuse, or if this fails to occur will run a risk of becoming damaged, whilst the bulbs will inevitably blow if they are switched on and the engine revved up. The reason for the inclusion of the third terminal on the switch will now become apparent, its function being to earth the coil and thus bring the engine together with the dynamo to a standstill.

### Precaution When Coasting

A word of warning is necessary against the operation of the master switch when coasting. If it is opened

under such circumstances, the engine will continue to revolve by virtue of the momentum of the car, assuming it is used for braking purposes and therefore connected through the gear box to the back axle. Again, the fuse will either blow, or the bulbs burn out if switched on. It is decidedly not permissible to use the master switch on such occasions.

### Switch Action

To deal with the second question, if the car will not start until the additional wire has been taken off the coil terminal, then obviously this latter is still earthed to the chassis. Bear in mind that the action of the switch is to open the battery circuit and to earth the coil, in just the same way that it earths the contact breaker primary screw in the case of a magneto. For some reason there appears to be considerable misapprehension on this point. With the switch closed and the third or coil terminal unearthed, battery current should be fed to the coil and normal conditions prevail. If they do not do so the switch action is faulty, as can be proved by testing between the switch coil terminal and earth, when a closed circuit will be in evidence. Before condemning the switch, make sure that the knob has been turned to its full extent. The same remarks apply where periodical fuse or bulb blowing asserts itself with the switch in the "on" position. Prior to running over the remainder of the equipment, satisfy yourself that the owner is using the switch properly, and turning it to the full limit of its travel.

(Continued from column 3)

All circuits are therefore functioning upon 12 volts, and as the cutout is under energisation, the cutout contacts C1 will be closed while the extra cutout contacts C2 will be open. Thus, contacts C1 complete the charging circuit, but contacts C2 rupture the starter-switch operating circuit, even though through defect or inadvertent operation the starter-switch operating press-button SOL be depressed.

The circuits on Fig. 4 are V1—dynamotor shunt field, V2 cutout shunt, V3 charging dividing into paths 3A and 3B for each battery respectively.

## About This Month's Diagram

(Continued from page 177)

of which it divides into two further paths S1 and 4D. Path S1 includes the starter-switch operating press button SOL, the extra cutout contacts C2, the starter-switch operating coil terminals t1 and t2 and earth. Path 4D includes the warning lamp the main fuse MF, cutout terminal 5, stationary starter-switch contact 5, dynamotor terminal 5, the dynamotor, and earth.

It follows therefore that the main discharge circuit can function only upon 12 volts during starter-switch contact, and that even if this contact could be made while the engine is running the cutout windings could not suffer damage, for the shunt coil thereof is wired across the terminals of but one battery unit, terminals B2+ and B2-, while the series winding, even assuming cutout points closed, is wired across the terminals 6+ and - of the other battery unit via the ammeter, the lighting switch, cutout A terminal, the main fuse, stationary contact 5, dynamotor terminal 5, the dynamotor, and earth.

### Charging

Returning to the subject of operation and assuming the engine has started and has reached a speed corresponding with "charge," while the starter-switch operating press button has been duly released, the state of affairs will be as per Fig. 4. Here it will be seen that since the starter-switch operating coil is no longer under energisation the springs A and B, Fig. 2, cause the moving starter and charging switch contacts to move out and into contact respectively. Consequently, stationary contacts B2+ and 6 become bridged, while stationary contact B2- is earthed via the internal lead and the switch case.

Moreover, the two batteries are placed in parallel since the charging current from the ammeter enters at contact 6 and returns to the dynamotor in two paths. Of these, one includes one battery and earth, the other, two adjacent tongue-pieces and one part of the moving charging switch contact, contact B2+, the second battery, contact B2-, the remaining tongue-piece, and part of the moving charging switch contact, the internal lead, and earth.

(Continued at foot of column 2)

# Rotax 24-Volt Starting

**A**LTHOUGH the use of 24-volt starting is commonplace on heavy commercial vehicles, it has not been fitted to many makes of cars. If trouble develops on a system of this type it is essential to have a clear understanding of the circuit arrangement as special conditions arise which do not apply in 12-volt sets.

One example of 24-volt starting is to be found on 1933-34 Talbot cars in which a Rotax dynamotor driving direct is wired through a series-parallel starter solenoid switch, operating by connecting both 12-volt battery units in series for starting and in parallel for lighting and charging. This Switch-Rotax type SOL-CT3, governs the successful

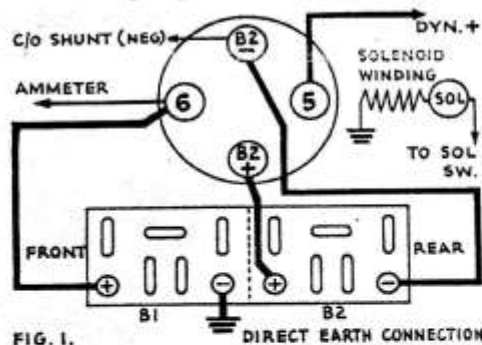

FIG. 1.

working of the whole installation and its wiring and internal connections are well worth careful study, as we are thereby enabled to trace causes of trouble with a knowledge of what results tests should show.

## Series-Parallel Switch

Fig. 1 shows the external connections of switch and batteries. The switch unit is a robust piece of work contained in a cast aluminium frame and situated on a chassis bracket underneath the toe-board on the near side—just in front of the battery. On the near side are four main terminals, marked as shown, three being connected to the battery terminals and the fourth to the dynamotor positive terminal through the starter cables. The body of the switch—secured to the cast base by a face joint and screws, contains a solenoid winding and a spring plunger assembly, the solenoid terminal being situated in front and the other end of the winding earthed.

Lighter cables are connected to terminals B2 neg. and 6, these leading to the cutout shunt (earth) connection and the ammeter re-

## And 12 Volt Lighting on 1933/34 Talbot Cars

spectively. The battery is a single-unit divided into two twelve-volt components with terminals positioned as indicated. Note that only the negative post of B1 is earthed direct.

The interior of the base casting contains four stout copper sector plates, one to each main terminal, and a central contact disc with two small sectors. The plunger assembly bears against a main contact ring which carries two 180° sector contacts normally held off by spring pressure. Action of the switch is as follows: In the charging position (Fig. 2) or when the car is stationary, the central contact disc is held against the main sector plates by spring pressure. It cannot turn in relation to the sector plates, so that the two small sectors always occupy the same relative positions. One bridges the sectors of terminals 6 and B2 pos., while the other, which is internally earthed by a flexible connection, contacts with B2 neg. As the neg. terminal of battery B1 is already earthed to the chassis, we have both pairs of terminals bridged and the batteries are in parallel, providing 12 volts for charging and lighting.

## Supply to Solenoid

The solenoid switch is supplied through the ignition switch. If this is now closed and the starter button pressed, current from terminal 6 flows *via* the ammeter and both switches to terminal SOL, *via* winding to earth, energising the solenoid, which closes. As the plunger moves inward it compresses the spring holding the central contact disc and lifts this off the main sectors, following up by applying the starting contact ring sectors to the mains.

The position now is shown in Fig. 3, where it will be seen that the earthed contact is lifted from B2 neg. and this is now bridged to 6, while B2 pos. is bridged to 5. Current therefore flows from the positive terminal of battery B1 (No. 6) to negative of B2, the positive of B2 now being at 24 volts potential to earth, and bridged to No. 5, when current flows to the dynamotor and

earth, returning to negative of B1 through the chassis.

## Two Important Points

Two important points should first be made clear. The first is that lighting and ignition, etc., are always fed by terminal 6, which is B1 pos. and therefore cannot, in the ordinary way, ever have 24 volts impressed on them. When the starter is in operation, these circuits remain still "tapped off," so to express it, at 12 volts to earth. The second point is that the earthing of battery B2 neg. is *via* the flexible lead attached to the small sector of the central contact disc—a connection of great importance. Furthermore, it should be noted that the cutout shunt return circuit is not earthed

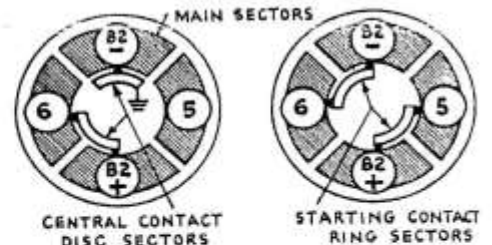

FIG. 2 CHARGING

FIG. 3 STARTING

direct as is usual, but is connected to earth *via* this flexible connection.

When the starter is operated, the pushing off of the central disc opens this earth path. The object of this arrangement is to avoid impressing 24 volts on the cutout winding. This voltage is applied to dynamotor pos. (No. 5 terminal) and, consequently, the cutout input terminal and the live end of the shunt, but as the earth end remains connected only to the wiring leading to B2 neg. in the starting position of the switch, the cutout shunt only receives the voltage of battery B1, as 6 and B2 neg. are bridged.

When a case of blowing main or field fuses has to be investigated the flexible earth connection in the switch should always be checked. If the connection is broken or intermittent, the cutout will not close and the dynamotor voltage will rise about safe limits.

Access to the switch involves removal of the battery and connections, when it will be seen that the switch body is secured to the chassis bracket by two cast feet bolted to the bracket. Particular

(Continued on page 90)



# "Servisnag" No. 12. Lucas LR4-LR5 Regulators

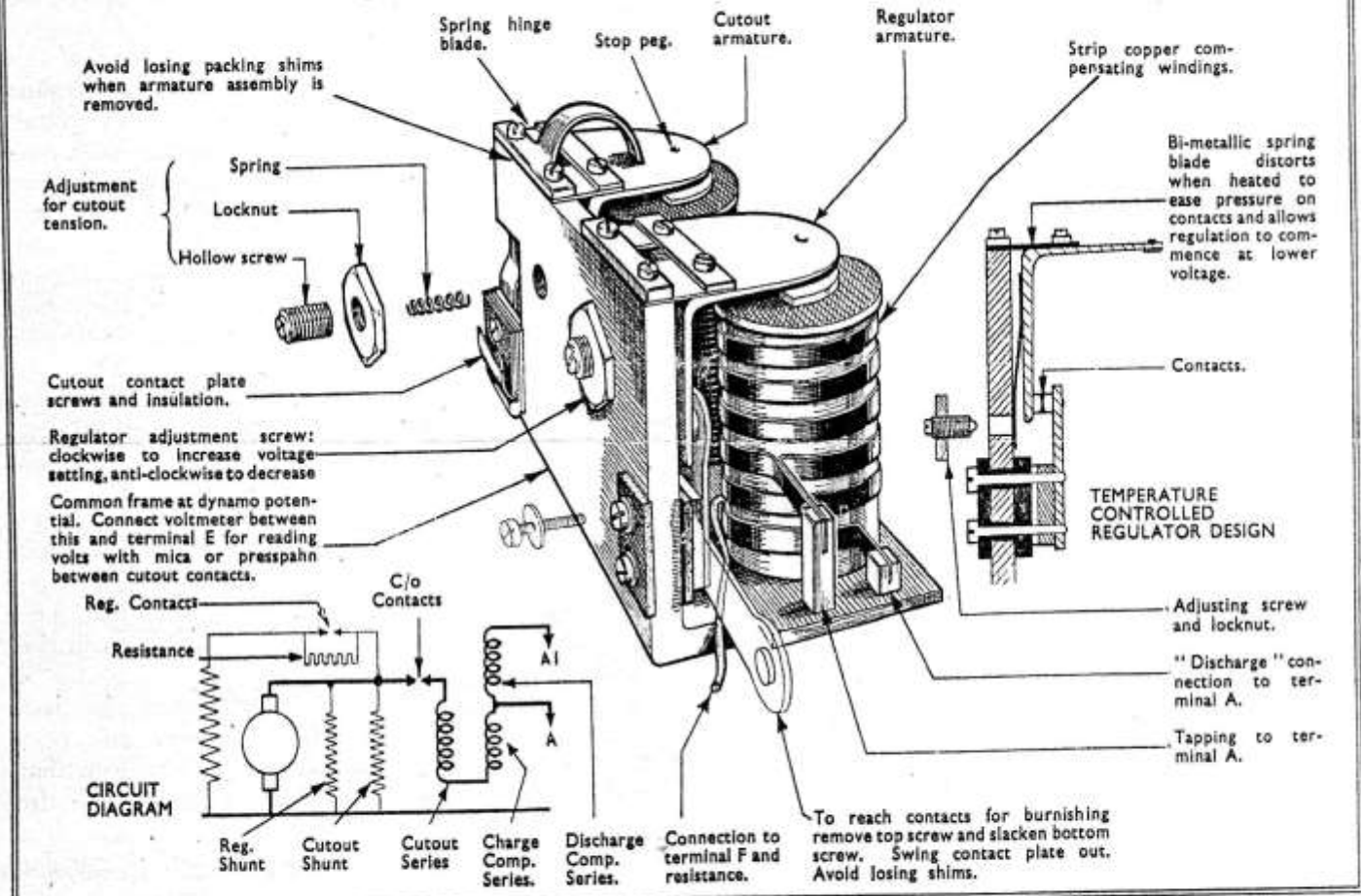

ROTA X 12/24V SOLENOID TYPE SOL/CT3 (105-75-110)

CORRECT ASSEMBLY OF KEYED MAIN TERMINALS KEYS AT 12 O'CLOCK

2B/012 B2 - in cut out has earths and out prevents 24V pulling if in no B2 - & B14 in series. only 12V is applied to cut out.

2B/012 TO 5 TERMINAL (INPUT) OR CUT OUT

DYNAMOTOR

44/012 VIA AMMETER FEEDS ALL CIRCUITS

- A.B.C. PARALLEL FIXED CONTACTS.
- D.E.F.G. SERIES FIXED CONTACTS
- H. MOVING PARALLEL CONTACT TO EARTH VIA SPINDLE & LEAD
- J. MOVING PARALLEL CONTACT +

SECOND BATTERY EARTHS THRO' SWITCH

FIRST BATTERY PERMANENTLY EARTHED

When switch is in the normal parallel condition the contact starts H J is spring loaded into contact with terminals A, B, C. The effect of this is to earth the second battery through H and to connect the + terminals of both batteries together through J.

When the dynamotor is required to function as a starter the solenoid is energised. This first opens contacts B.H. & A-J-C. The ignition lights etc are then fed from the first battery. Further involvement of the solenoid plunges causes the main "gas" contacts to engage. For clarity these are represented in the above diagram as K etc in fact they are a

connected in a parabolic or similar close behind D, E & G. This connects the + of the first battery to the negative of the second and the

# TALBOT 95/105/110 DYNAMOTOR SYSTEMS: BATTERY CHARGING

*By Martin Cragg*

I have read with interest the recent articles in the magazine on this topic. Suggested solutions to the problem of over-charging range from: a half charge switch modification; custom voltage control; or fitting a modern alternator. There is no doubt that the fitting of some form of voltage regulator or an additional alternator would be preferable to the constant current regulator fitted to the Talbot, which was a charging method used for most cars until voltage control made its appearance in the early thirties. However, the fitting of a voltage regulator, as I did to AV48 in the mid sixties (see note 1 below), was not the complete answer to my battery charging problems. My solution overcame possible over-charging but did not solve the chronic under-charging of my number two battery. This was due to the poor condition of the paralleling contacts within the starter solenoid switch and, try as I may; I could never guarantee their reliable operation. I could get them to work on the bench, they would show continuity when in the car, but as soon as they were asked to carry current to the second battery, they would often as not fail to do so.

I suspect that this is the underlying problem in many such cars today and, if they are still operating on current control, this will result in possible over-charging of battery No. 1 and definite under-charging of battery No. 2. The fitting of a half charge facility is not going to solve this underlying problem. When the contacts work perfectly the batteries are charged equally and each receives half the dynamotor output. This is equivalent to permanently running on the half-charge setting as fitted to the 75/90 models.

After putting up with my situation for over forty years I decided SOMETHING MUST BE DONE and I offer the following add-on circuit which ensures reliable battery paralleling without having to modify the starter solenoid in any way. It uses four standard automobile type change-over relays (shown in dotted lines), a resistor and a diode (Figure 1). This is a starting point and a more detailed article which explains operation of the circuit and component details will be available on the forum or direct from me.

I regard the fitting of such a modification as this as a prerequisite to the fitting of any other modification and, in many cases, depending how the car is used, maybe all that's necessary to provide motoring free of such battery problems. If Talbot current control is retained, the fitting an automobile type voltmeter will show if the batteries are being over-charged: headlights and accessories can then be switched on to mop up the excess current.

*Note 1: My solution then was to rewind the dynamotor shunt field coils and use a Lucas RB106 voltage regulator. Thus I have a non-standard dynamotor on my car. I have recently designed and bench tested an electronic voltage regulator to work with the standard dynamotor. I have yet to try them on the car – watch this space.*



# A. ARCHER

MOTOR ENGINEER AND MACHINIST

77 HIGH STREET  
DUNMOW  
ESSEX CM6 1AE  
Telephone: Gt. DUNMOW 2802

SPECIALIST IN  
VINTAGE



Vauxhalls

## ROTAX DYNAMOTOR

Rotax 12/24 volt Dynamotor Type D.M.9. Very heavy. Usual dynamotor circuit, 3 heavy series field coils (starting), 3 light shunt field coils (charging). Armature has 85 commutator bars (automotive record?) 17 slots. Wave wound.

Brush spring tension (main) 16 - 18 ozs ) This is critical  
" " " (field) 11 - 13 ozs )

Brushes are of a copper-carbon mix. Substitution of plain carbon material produces a reduction of some 19% of locked up torque.

Brush dimensions:-

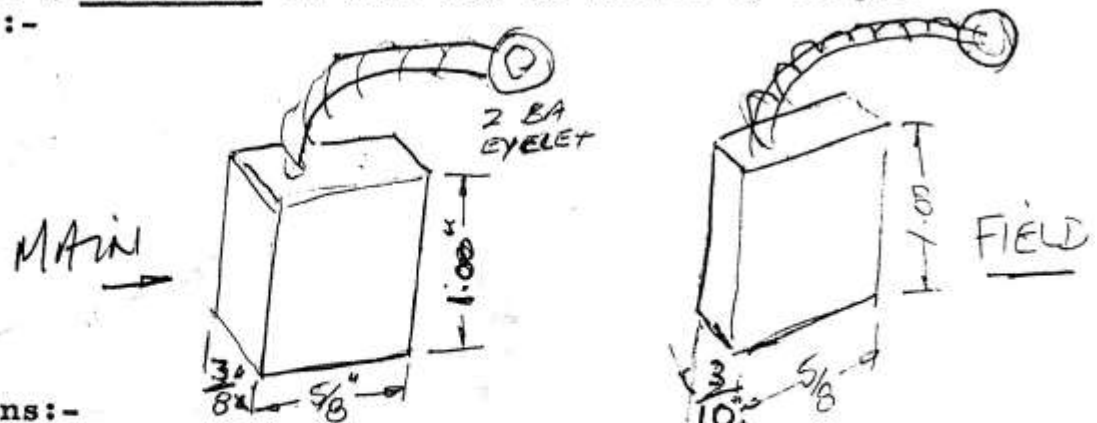

Bearing dimensions:-

Drive end: 35 x 80 x 14 98307 Comm. end:  $\frac{3}{4}$ " x  $1\frac{7}{8}$ " x  $\frac{5}{16}$ " RLS6

Starter Lock Torque: 2 x 12v batts. 85 lbs/ft at 12v.

1 x 12v batt. 45 lbs/ft at 8v.

The shunt field was found to influence the lock torque. Typical figures - with shunt field 90 lbs/ft, without shunt field 78 lbs/ft.

Therefore, for best results brushes should be copper-carbon mix, properly bedded and the external field circuit should be complete. On the vehicle it is beneficial to fit an engine/chassis earth band. Makers figure 85/95 lbs/ft at 11.5v and 520 amps. 5980w. 8hp or with 50% efficiency, say 4hp !!

In its charging mode the following particulars apply:-

Cut in: 650/750 rpm 12 dynamo volts

Mix output: 14.5/15.5 amps @ 1,400/1,600 rpm 16 dynamo volts

The D.M.9 uses two 12v batteries in series for starting. For charging they are connected in parallel, therefore each battery received HALF the indicated output. The change-over is controlled by a special (unique?) solenoid, the Rotax SOL/CT8.

# Servicing Rotax Dynamotors

THE Rotax dynamotors of the D.M. series, such as are standard equipment on the larger Talbot models, comprise the largest and heaviest single unit machines which the electrical service station is likely to have to deal with. From models DM6 to DM9 and onwards the machines require careful handling in dismantling and refitting on the car. Similarly, service overhauling

## Care is Needed if Snags are to be Avoided

bar, so that they can be forced into place with least risk of flying out. The chamfered edges of the blocks must be forward and the tongue of the armature shaft pressed into place between the blocks after correct alignment, using leverage against the front of the dynamotor. It is unwise to attempt man-handling the dynamotor on account of its weight and awkward position. Overhead support is only possible at the forward end owing to radiator overhang.

A good method is to rig a wooden cradle to receive it, as shown in Fig. 3. Provision for taking the weight of the machine when it is levered out and freed from the engine, and for lowering till it can be drawn forward under the cross bar, can be devised by small wide base jacks, and the same arrangement is used in reassembling. Before attempting to engage the driving coupling to the engine the dynamotor must be lined up true at correct height and central. This can be readily gauged by the position of the starting dog seen through the handle bracket hole, the handle bracket assembly being removed. Also the tongue on the

and causing damage. The starting dog is keyed and secured by a  $\frac{1}{4}$  in. Whit. sunk set screw with a hexagon recess. A piece of round steel bent at right angles and filed hexagon to fit will remove the screw easily. The dog can be levered off or a small puller used. Do not suspend the

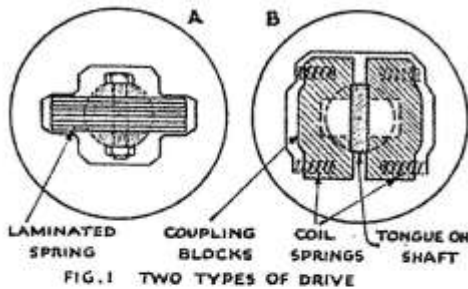

calls for special care as these machines perform arduous duty, and the work involved in putting right an unsatisfactory job is not what one would choose to undertake "f.o.c."—apart from the loss of business prestige. The following practical pointers may assist in the avoidance of snags and promote the profitable and punctual execution of necessary repairs.

### Engine Mounting

In the case of the Talbot models, the dynamotor is front mounted on the crankcase with a deep spigot and six studs (four in early models). The starting dog is keyed to the forward extension of the armature shaft and a spring drive is fitted between crankshaft coupling and armature shaft. Two types of drive are shown in the illustration, Fig. 1. The first (A) consists of a flat leaf spring through-bolted in a slot in the rear end of the armature shaft, the ends of the spring entering slots in the crankshaft coupling.

The second type (B) consists of a tongue extension of the armature shaft which is gripped between two steel blocks, these being held against the tongue by four square-section coil springs housed in recesses in the coupling. The springs are short but exceedingly stiff owing to stout section, and if one or more is broken, are almost sure to fly out when the machine is removed. When reassembling, the blocks and springs are placed as shown in Fig. 2 with a wooden block and small jack abutting against the dumb iron cross

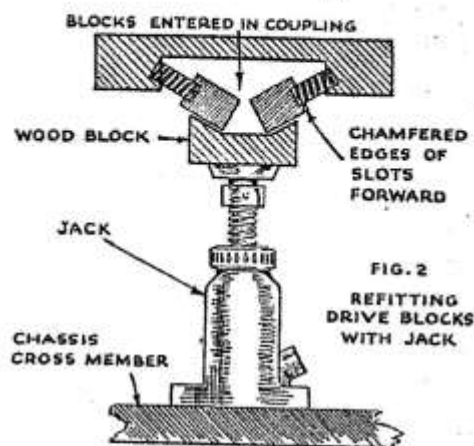

shaft or the leaf spring coupling must line up correctly with the appropriate slots in the engine coupling. When this is done the machine can be easily levered back into place and the weight taken by two top studs before removing cradle.

### Dismantling Machine

With the machine on the bench, a stout wooden block is the safest seating to prevent the carcass rolling

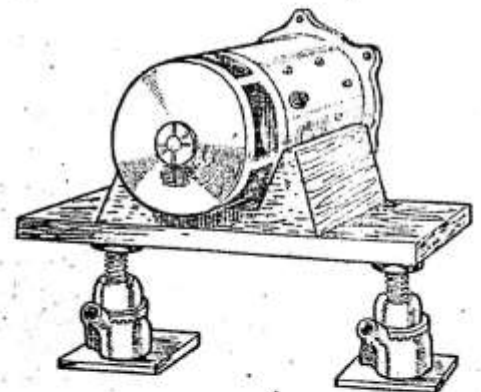

machine in a screw press to withdraw the dog or it may drop suddenly and cause damage. Four main brushes and one field brush are detached, and the series field connection to one live brush holder slacked off. Eight cheese-head screws sunk in counter-bored secure the drive end bracket. Mark positions of comm. end casting, carcass, and drive end bracket before separating. With these screws out and armature free the carcass should be secured in a big vice or held on the block by an assistant while the armature with D.E. assembly is driven out, using a stout copper drift on the front end of the shaft. Once the front bearing housing is free, the armature can be lifted out. In DM7-9 machines it is easier to slack off the clamp screws holding the two brush rings on the bearing housing extension of the C.E. casting and withdraw the latter, leaving the brush rings attached to field connections. The positions of both brush rings and the casting must be first noted and marked.

### Inspection and Test

Note that a six-pole layout is used with three series windings, and three shunt windings on alternate pole shoes. There is no direct inter-connection of fields. The series windings connect the main positive terminal with one main (live) brush holder, which is bridged with heavy

(Continued on page 302)

# Dynamotor Service

(Continued from page 300)

copper conductor to the other insulated holder. The other two main brushes are negative earthed. The field shunt windings connect the field terminal of the rear end of the carcass with the "third" brush. In DM9-3 machines a half charge resistance is former-wound in a ring situated just within the forward end of the yoke and connected between the main positive terminal, and a third terminal marked "7A." Other markings are "5+" and "7F."

The armature is wave-wound of copper strip conductors soldered to 85 commutator bars. There should be no "earths" on either fields, armature windings, or live brush holders. Clean out brush carbon before testing windings on mains voltage. Check conductivity of inter-brush and inter-coil connections. Verify condition of bearings and see that front bearing is not sliding in its brass housing. If fields are removed for re-insulating or replacement, mark each pole shoe so that it is replaced in same position end for end. Take particular care that all soldered connections are properly remade—especially those of series field to terminal and intercoil joints, which carry heavy current. Check brush tension to 16 ozs. on mains and 12 ozs. on control brush in assembled machine.

In machining commutator, pay special attention to correct centring.

If poppet centre is out with bearing, true up or support armature by securing bearing housing in lathe centre bracket. It is essential that the commutator runs true with the bearing to avoid up-and-down riding of the brushes with attendant heavy side wear. Undercut micas evenly to equal depth—which must be as shallow as possible and extending full width of mica.

## Assembling

When refitting armature in carcass note that a lug is punched up in front bearing housing. This lug must engage a slot milled out in the casting extension which receives the bearing housing. A wood mallet on shaft end will enter armature to enable four alternate drive-end plate screws to be started. These are then screwed in half a turn each all round to bring the assembly evenly together.

If the armature turns stiffly when end plate assembly is fully home, a sharp bump with the mallet will usually ensure smooth free rotation. The stiffness is due to slight self-loading of the bearings caused by thrust load of forcing assembly together. Make sure no pole shoe rub is present, and use socket wrench to pull up pole screws. Well tighten

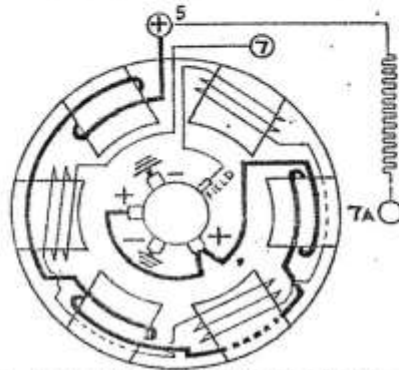

FIG. 4 INTERNAL CIRCUITS OF D.M.9-3 DYNAMOTOR

and lock all eight D.E. plate screws after machine has been tested.

On the bench a chuck drive on the front end of the shaft can be used with clockwise rotation. If the drive is coupled to the rear end, the rotation is anticlockwise. For half charge bridge 7 and 7A terminals. For full charge bridge 7 and 5+ terminals.

Give final output adjustment on the car, setting to maximum of 15 amps.

Allow for further adjustment if brushes are not fully bedded, but it is better to bed the brushes on the bench than to depend on running.

If not already provided, fit pres palm lining to cover band to exclude water and secure against shorting brush leads.

## Talbot Traffic Signals

In Talbot cars of 1934-36, the traffic signals are arranged as illuminate arrows, two in the lower radiato shell, and two in the stop rear lamp housing. When the steering column switch is operated the front and rear arrows are lighted on the corresponding side, and in addition a tell-tale lamp in the dash panel is illuminated. The front lamps are 12 volt 6 watt bulbs, but the tell-tale and rear bulbs are 6 volt 6 watt, and are wired in series. Care must be taken in replacing to fit bulbs of equal wattage and correct voltage, and if the tell-tale has burnt out, leaving the rear bulb intact, a short in the feed to the rear bulb should be looked for.

(Continued at foot of column 3)

(Continued from column 2)

In fitting trafficators or semaphore signals of regulation type they should be wired in parallel with the front lamps. The terminals for these circuits are housed in the main junction box on the rear side front of the engine bulkhead, the front terminals for trafficator connection are LS and RS, while the terminals for rear connections are LR and RR. All circuits are controlled by the ignition switch.

AUTOMOBILE ELECTRICITY for October, 1937

# ROTAX DYNAMOTOR BRUSH REPLACEMENT

*By Rob May*

For those of you who have chosen to replace the brushes in your Rotax Dynamotor, may I offer the following.

Over the years a vast amount has been written about these devices with which our Talbot cars are blessed. Quite why I chose to follow the 'originality route' when I constructed my Talbot 105 VDP tourer, I am not sure. However my car, like most 105s, carries this vast amount of electrical 'gubbins' (a DM9 Rotax Dynamotor) in front of the radiator contributing to excessive weight with modest electrical output, just so I can experience the joy of near silence when starting.

Anyway, after 15,000 miles and three years of creating large amounts of carbon dust necessitating the removal and regular cleaning of the brushes, I had had enough. From A. Archer, and the ever helpful Colin Staines, I purchased a new set of five dynamotor brushes and a most informative instruction sheet.

The purchase of a laboratory quality, low capacity spring balance further emptied my pocket, but at least I can now accurately measure the spring tensions. (Annoyingly they were all within tolerance and so my hope of generating a few more amps by an increase in spring tension, was immediately thwarted.)

By then I had read the instruction sheet and noted that A. Archer's brushes were a copper-carbon mix, whereas mine appeared to be carbon alone. Hope re-emerged!

However it was the sentence sitting quietly in the body of the instruction sheet which gave me the most concern and which has caused me to put my experiences on paper. "The brushes should be bedded in using a strip of fine paper around the commutator". I am sure many Talbot owners have done just that, but I found it almost impossible. There must be another, easier way to bed in the brushes.

I have the highest regard for the Archer establishment and their many printed words of wisdom which help to keep our cars on the road, but I found the following process to be an effective and simple way of creating the necessary concave curvature on the working end of the new brushes. It does require the use of a small metal cutting lathe and an old angle grinder cutting disc. (If you don't own a lathe, use a friend's for half an hour – even better get him to do it for you. If you don't own an angle grinder how on earth do you keep an old car on the road!) Anyway, enough of the blather. Here goes:-

Measure the diameter of your commutator. Because of the surrounding five brush holders fighting for space around the commutator and the dynamotor body casting, this is easier said than done. (I measured the outside diameter of the machined part of the dynamotor D; measured the depth of the commutator surface from the outside diameter of the dynamotor, d. Ergo, commutator diameter is  $D - 2d$ .) Mine was 64mm.

Number the old brushes for later comparison with the new, to ensure that you replace like with like around the commutator.

Reduce the diameter of an old angle grinder 'cutting' disc to that of your commutator and attach a bolt/stud centrally in the disc. Insert the bolt in to the chuck of a lathe so that the disc spins centrally, since this will act as the cutting tool.

Carefully mount a new dynamotor brush in to the toolholder of the lathe at right angles to the cutting disc.



Start the lathe and take a light cut/grind along the face of the brush. Ensure it is central and parallel and replicates the wear pattern of the old brush. (This is not difficult and allowed me to replicate one brush with a 5 degree wear pattern from normal.) Continue with a deeper cut until the end face of the brush is entirely concave, and resembles the wear on the old brush. Cut/grind the faces of all five brushes. (I was surprised what a fine finish there was to the concave faces.)

Assemble the new brushes in to the dynamotor in exactly the same location as the originals. Hence the need to number the old and new brushes. (Of course, you still get carbon dust up your nose and in your eyes whilst assembling the brushes, but its for a far shorter period than if you had to laboriously grind in the brushes in situ.)

When I came to start my car the dynamotor rotated the engine noticeably faster than before, and the charge rate was improved.

Now, after another 1,000 miles of running the car, the brushes must have further bedded in, for all seems to be working well and the charge rate is consistent.

NB. The above may seem time consuming but it has taken me far longer to write about – than do it!

---

## ROTAX DYNAMOTOR - ARMATURE

*By Tony Ward*

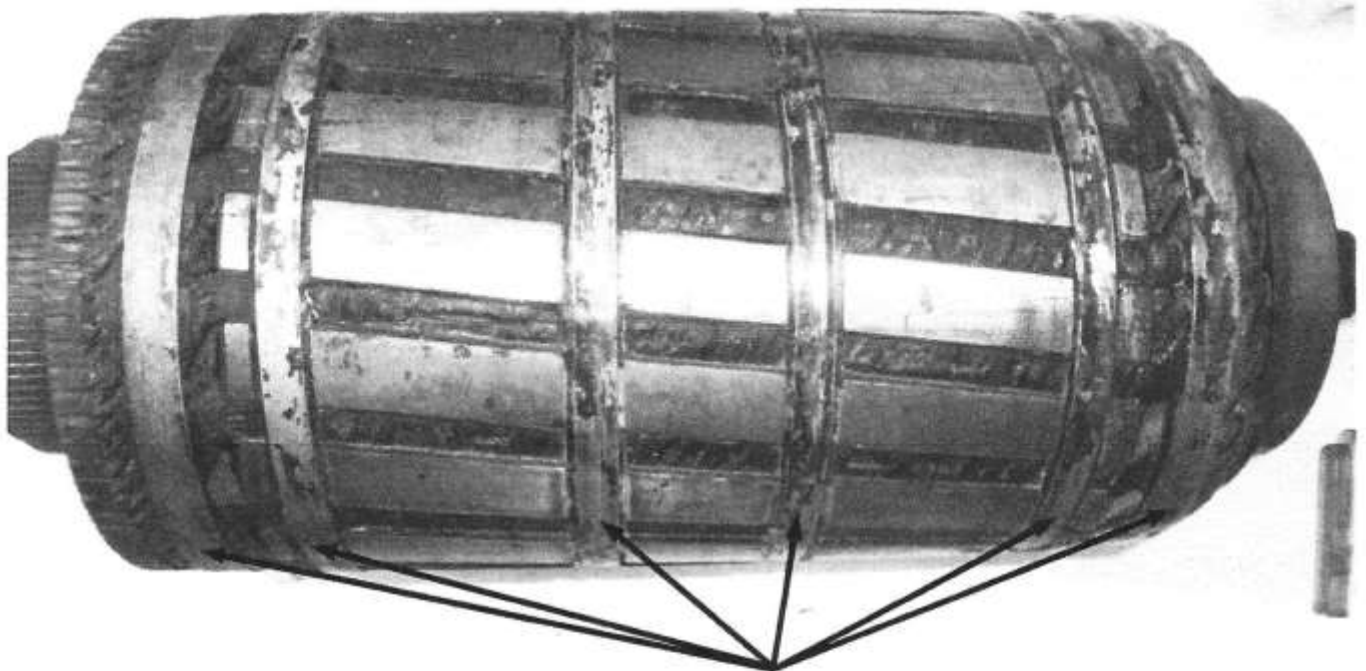

*Above: The fine wire wrapped around the armature*

To update members as to what happened with the dynamotor at Montlhery on BLO110, the fine wire which is wrapped approx 15 turns as indicated above had come undone in one of the sections. A small piece had shorted out the field windings which was causing the first problem of no charge and then over the weekend the rest had wrapped itself around the armature causing the large sparks and starting failure. It appears this has happened to a number of members and maybe becoming a common fault. Something to look out for when diagnosing a fault if this thin wire can be seen when inspecting the brushes!

Table 1. 12 Volt System

Model	Year	Dynomotor	Dashboard	Cut out & Junction box	Steering column switch	Half charge
14/45	1926-30	DM6	FT48/3			Yes
65	1933	DM10	FT48/21C	11960 or 11730	SP/CT1	Yes
65	1934	DM11	FT48/21C*	11960/2	SP/CT1	Yes
75 Long chassis & 90	1932 1933 1934	DM9/1 or DM9/3	FT48/16,18, 19,20,23	11570 or 11960/3	SP/CT2	Yes
75 Short chassis	1933	DM9/1	FT48/21A	11730 or 11960	SP/CT3 (sic)	Yes
75 Short chassis	1934	DM 9/3	FT48/21D or DR	11960/2	SP/CT2	Yes
75	1935	DM9/3	FT97/2	11960/2	SP/CT2	Yes

Note: \* After 825 chassis.

Table 2. 12/24 Volt system

95	1933 1934	DM9 or DM9/4	FT48/15	11930 or 9263/3	SP/CT2	No
105 & 105 Speed	1933 1934	DM9 or DM9/4	FT81/2	11930 or 9263/3	SP/CT2	No
95,105, 3½ Lt	1935	DM9/4	FT97/3	11960	SP/CT2	No
3½ Lt Limousine	1936	DM9/4	FT97/3	11930	SP/CT2	No

Table 3. Early Rotax systems

Model	Year	Starter	Dynamo	Dashboard	Voltage
8/18	1922-24		AT20		6
8/18, 10/23, 12/32	1923-24			FT17	6
18/55	1925-26	MT20	AT90		12

Table 4. Lucas systems

Model	Year	Starter	Dynamo	Regulator & Fuse box
75, 105, 3½ Lt	1936-37	M45AL S3.5	C5H BQ2-0	RJF20 L38

TALBOT 95, 105, 110

CUT-OUT ON BOTH 12/24V FUNCTION BOARD. BOND W/RES 926530C 11930

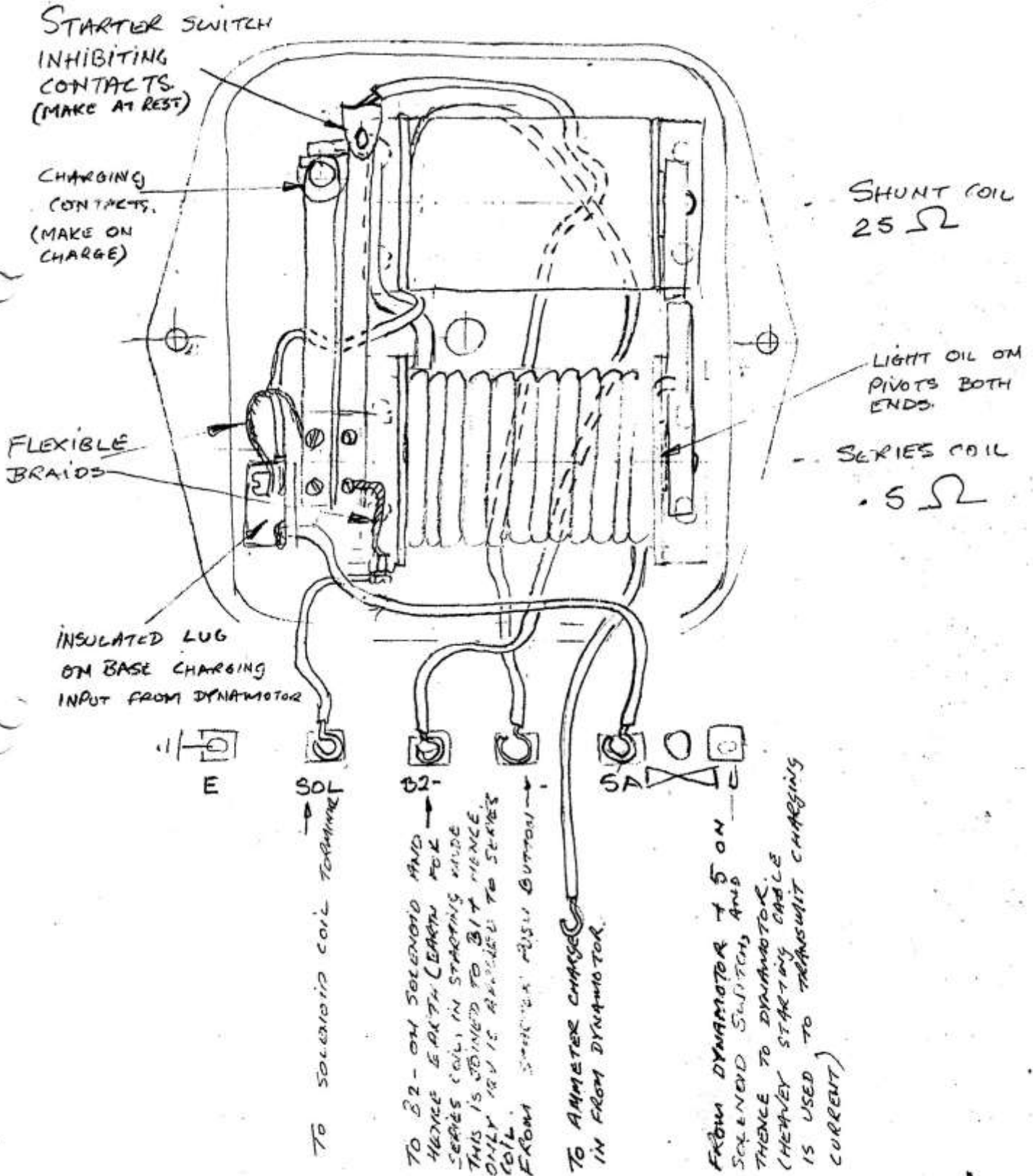

# Equipment and Test Data for Rotax Set on 1933/34 Talbot "95"

## EQUIPMENT

Component.	Type No.	Component.	Type No.
Battery	VP.159	Instrument Board	FT.45/15
Coil. (Delco Remy)	529A	Side Lamps	K.704/R1
Cutout and Junction Box Unit	9263/8 or 11930	Starter Change-over Switch	SOL/CT.3
Distributor. (Delco Remy)	66Z.B.	Steering Column Switch	SP/CT.2
Dynamo	B.M.9	Stop Switch	B.P.2
Head Lamps	K.506/8	Tail Lamp and Rear Indicator	K629, 630, 631 or 632

## TEST DATA

**Battery.**—Two 12 volts units. Capacity per unit: 75 a.h. at 10 hour rate. Charging voltage: 12. Starting voltage: 24. Plates per cell: 13. S.G. in service: 1.285-1.300 fully charged; 1.210 about half charged, and 1.160 or less fully discharged. Overall dimensions: 22½ in. x 8½ in. x 10½ in.

**Coil.**—Location: near side. Current draw: 1 amp at 2,500 engine r.p.m., and 2.5 amps on stall. Plug setting: .020 in. Plug compression test: at 105 lbs. per square in.

**Cutout and Junction Box.**—Combined unit with fuse unit. Fuses: 4, main charging, horn, accessories, and dynamo shunt field; capacities: shunt field 20 amps, all others 30 amps. Cut-in voltage: 12 dynamo volts. Cutout reverse current: 0-3 amps.

**Distributor.**—Location: near side. Drive: from camshaft. Order of firing: 1-5-3-6-2-4. Automatic advance: 36° engine; cuts in at 265 to 270 engine r.p.m. and finishes at 3,250 engine r.p.m. Breaker: normal gap setting: .018-.020 in.; spring tension, 17-21 ozs. Lubrication: shaft by greaser. Use medium cup grease and turn once every 500 miles. Apply trace of vaseline to breaker-cam, oil breaker pivot, and fill wick with light engine oil every 1,000 miles.

**Dynamo.**—Rotation: anti-clockwise viewed from drive end. Drive: direct from front end of crankshaft through special coupling. Field: 6 pole; three poles at 120° shunt wound with each coil connected in series, and three poles at 120° series wound with each coil connected in series. Armature: wave-wound; 17 slots, 85 commutator bars. Brushes: 4 main and a control brush; tension, 16-18 ozs. for main and 11-13 ozs. for control; connection, mains in pairs in parallel, control to shunt field. Dynamo cutting-in speed: (cold) 650-750 r.p.m. at 12 dynamo volts. Maximum dynamo output: (cold) 14.5-15.5 amps at 1,400-1,600 r.p.m. at 15 dynamo volts. Starter performance: lock torque, 85-95 lbs. ft. at 620 amps at 11.5 volts (approx). Starter change over switch: solenoid acting, places the two battery units in series for 24 volt operation when starting and in parallel for 12 volt operation when charging.

**Front Indicators.**—Bulbs: B.A.S. 10S.—12 volt 6 watt single contact.

**Head Lamps.**—Bulbs: 12 volt, 48 watt single contact.

**Instrument Board.**—Houses 25-0-25 centre-zero ammeter, lighting and ignition switch, starter solenoid operating press button, screen wiper switch, warning discharge lamp and resistance unit, two panel lamps and switch, oil pressure indicator lamps and resistance unit, direction indicator pilot lamps, lighter and inspection socket. Bulbs: warning discharge, 12 volt, 6 watt, double contact; panel lamps, 12 volt, 6 watt, single contact; oil indicator, 12 volt, 6 watt, double contact; direction indicator pilots, 6 volt, 6 watt, double contact. N.B.—Lighting and ignition switch positions shown below.

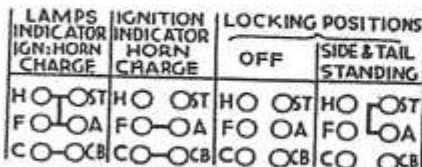

SWITCH CONNECTION DIAGRAM

**Side Lamps.**—Bulbs: B.A.S. 10S.—12 volt, 6 watt, single contact.

**Steering Column Switch.**—Controls head lamps, horn and direction indicators. Head lamp control: three positions—"Off," "1 On," and "2 On," giving both lamps off, near side lamp on, and both lamps on respectively. Horn control: by centre push. Direction indicator control: three positions—"Off," "Right" and "Left," giving all indicators and pilots off, right front and rear indicators and right pilot on, and left front and rear indicators and left pilot respectively.

**Tail Lamp.**—Duplex type with bulbs at extremities of a common fixture serving to house rear indicators and stop and reverse lamps. Bulbs: tail—2 of 12 volt, 6 watt, single contact; rear indicator, 2 of 6 volt, 6 watt, single contact; stop, 12 volt, 6 watt, single contact; and reverse, 12 volt, 6 watt, single contact. N.B.—Alternative tail lamp and rear indicator shown here.

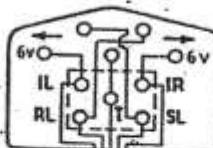

ALTERNATIVE TAIL LAMP & REAR INDICATOR - K-632

- N.B.—1. All units follow standard Rotax design.  
2. Connections and rotation of dynamotor in D311 as seen from front of vehicle and commutator end of machine. Change of rotation connections shown below.  
3. Cable colour scheme and terminal indication.

Terminal	Colour	Line
K	Yellow	Wiper Switch Feed.
A	Dark Red	Ammeter to Cutout.
K4	Brown	Spot Light, etc., Positive.
H	Dark Blue	Head Lamp, Positive.
S and T	Blue and White	Side and Tail Lamp Positive.
O	Light Blue	Oil Switch
F	Light Blue	Horn Indicator Switch Positive.
RS	Black and White	RH Pilot Lamp.
RR	Purple	RH Pilot Lamp.
LS	Grey	LH Pilot Lamp.
LR	White	LH Pilot Lamp.
K	Yellow	Horn and Indicator Switch Feed.
K8	Black and Red	Horn.
H	Dark Blue	Head Lamp, Positive.
LS	Grey	LH Pilot Lamp.
RS	Black and White	RH Pilot Lamp.
LH	Brown and White	Head Lamp L.
RH	Purple and White	Head Lamp R.
IR	Green	Rear Indicator R Positive.
IL	Black	Rear Indicator L Positive.
8L	Black and Yellow	Stop Light, Positive.
8R	Natural	Reverse Light Positive.
6A	Black and Green	Ignition Warning Lamp.
+	Yellow	Brake Switch Positive.
5	Red and Yellow	Dynamo Positive.
7	Green and Yellow	Shunt Field Positive.
0	Green and White	Coil Feed.
B2	Black and Brown	Cutout Negative.
SOL	Black and Blue	Sol Push Sw. to Starter Switch
—	Black and Yellow	Earth Wire for K631 Only.

4. Circuits on D311 as follows:—

V1. Dynamo motor shunt field.

V2. Cutout shunt coil.

V3. Charging to terminal 6 on starter change-over switch where circuit divides into two paths in parallel, path 3A to one battery and path 3B to the other.

V4A and V4B. Parallel battery discharge to starter change-over switch where paths unite and form main discharge on circuit 4, passing via ammeter to lighting and ignition switch; at ammeter terminal 6 circuit 4 is tapped to supply the lights and inspection lamp socket, while at the lighting and ignition switch it divides into four parallel circuits, three 4D, 4E and 4F at contact F, and 4G at contact C.

Circuit 4D.—Ignition discharge or no charge indicator warning lamp circuit. This circuit also divides on the feed side of the lamp for the supply of the solenoid operating the starter switch, the circuit being shown as 51.

Circuit 4E.—Main feed to terminal F on cutout junction box where circuit divides into three parallel paths, 5H via a strip connection at the back to terminal + feeding stop-switch; 5I via horn fuse to windscreen wiper switch; and 5J via horn fuse to horn push and main indicator feed.

Circuit 4F.—Includes the oil indicator pressure lamp, its resistance unit and switch which is located on the engine.

Circuit 4G.—Includes ignition-coil-contact-breaker circuit.

N.B.—When dual ignition is used the contact breaker connects with terminal C.B. on the cutout junction box.

## Connections for Alternative Direction of Rotation of Dynamotor

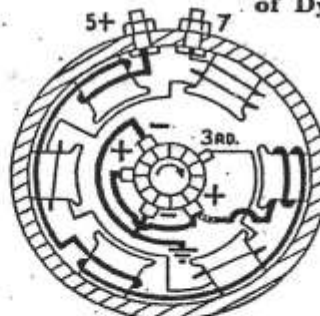

ANTI-CLOCK DRIVE

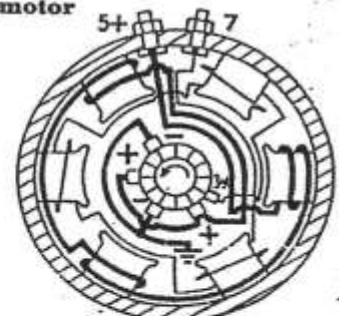

CLOCKWISE DRIVE

## CABLE COLOUR SCHEME

But a glance at the diagram on the reverse side of this sheet will be sufficient to show the importance of cable identification—especially when rewiring. Rapid cable identification is best facilitated by the adoption of a cable colour scheme, and in order that full use and advantage may be obtained from such a scheme, Ripaults supply adhesive tape in a variety of colours. Ripaults will gladly send a sample on request. Their address is 1, King's Road, St. Pancras, London, W.1.

## 1933/34 TALBOT '95' DYNAMOTOR B.M.9

DYNAMOTOR - Rotation: anti-clockwise viewed from drive end.

Drive: direct from front end of crankshaft through special coupling.

Field : 6 pole; three poles at 120° shunt wound with each coil connected in series, and three poles at 120° series wound with each coil connected in series.

Armature: wave wound; 17 slots, 85 commutator bars.

Brushes: 4 main and a control brush; tension 16-18 ozs. for main and 11-13 ozs. for control; connection, mains in pairs in parallel, control to shunt field.

Dynamo cutting in speed: (cold) 650-750 r.p.m. at 12 dynamo volts.

Maximum dynamo output: (cold) 14.5 - 15.5 amps at 1,400-1,600 r.p.m. at 15 dynamo volts.

Starter performance: lock torque, 85-95 lbs.ft. at 520 amps at 11.5 volts (approx.)

Starter changeover switch: solenoid acting, places the two battery units in series for 24 volt operation when starting and in parallel for 12 volt operation when charging.

# 14-45 Wiring Diagram

Kindly donated to the Talbot Owners' Club by John Dodd

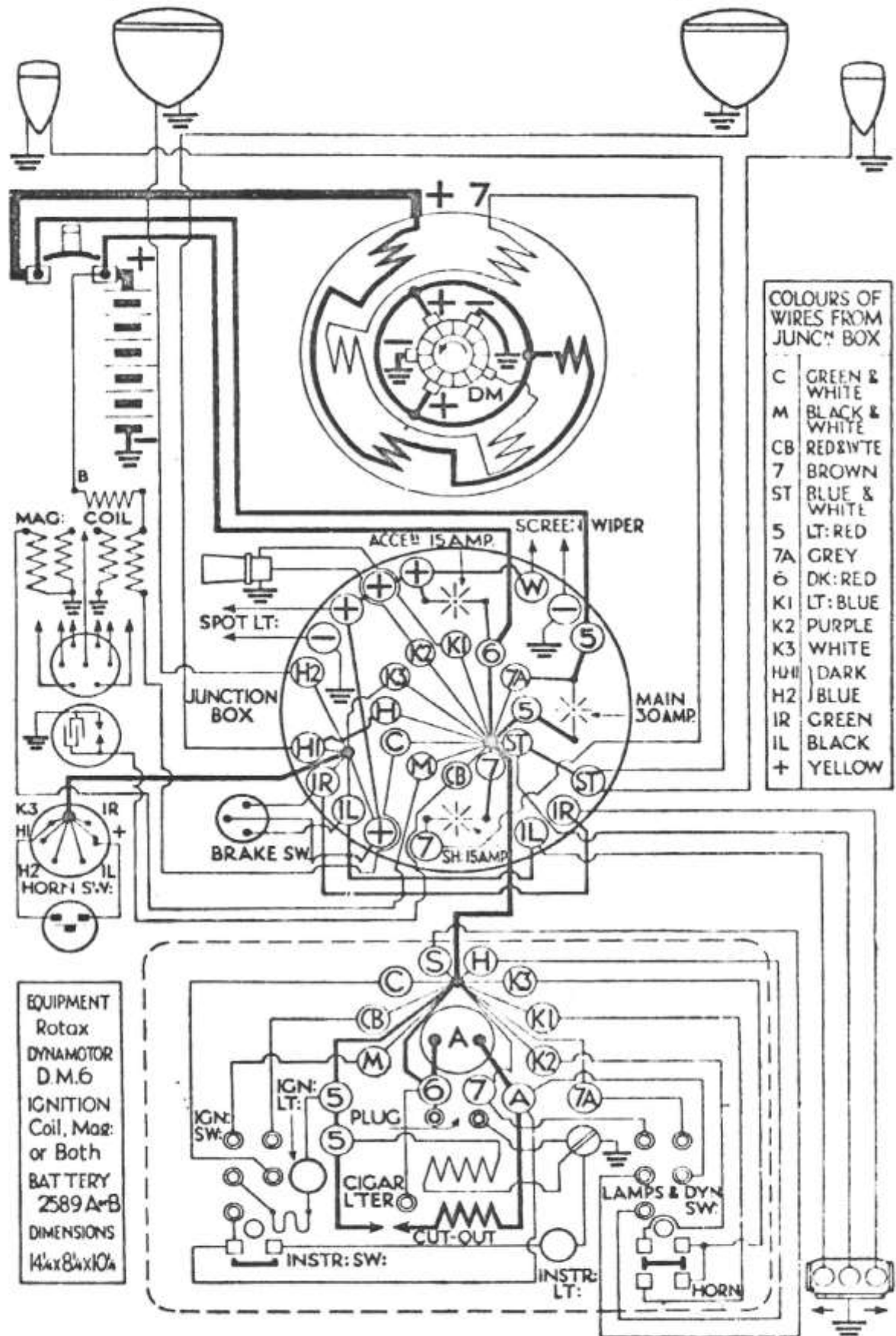

**COLOURS OF WIRES FROM JUNC<sup>n</sup> BOX**

C	GREEN & WHITE
M	BLACK & WHITE
CB	RED & WHITE
7	BROWN
ST	BLUE & WHITE
5	LT: RED
7A	GREY
6	DK: RED
K1	LT: BLUE
K2	PURPLE
K3	WHITE
H1	DARK
H2	BLUE
IR	GREEN
IL	BLACK
+	YELLOW

**EQUIPMENT**  
 Rotax  
 DYNAMOTOR  
 D.M.6  
 IGNITION  
 Coil, Mag:  
 or Both  
 BATTERY  
 2589 A+B  
 DIMENSIONS  
 14x8x10 1/4

1926 Talbot 14/45

<b>CABLES REQUIRED.</b>	Ripaults Cables are required here the cable number for each type is given below, and should be quoted when ordering.			
SWITCHBOARD TO JUNCTION BOX.	Ripaults Ripogloss No. R.S. 11C	HEAD LAMPS.	Ripaults Ripogloss No. R.212.1	BATTERY.
STARTER CABLE	Ripaults Ripogloss No. R.526/1	SIDE "	Ripaults Ripogloss No. R.212.1	HIGH TENSION.
		TAIL "	Ripaults Ripogloss No. R.211/1	LOW "

Kindly donated to the Talbot Owners' Club  
from the John Dodd Archive

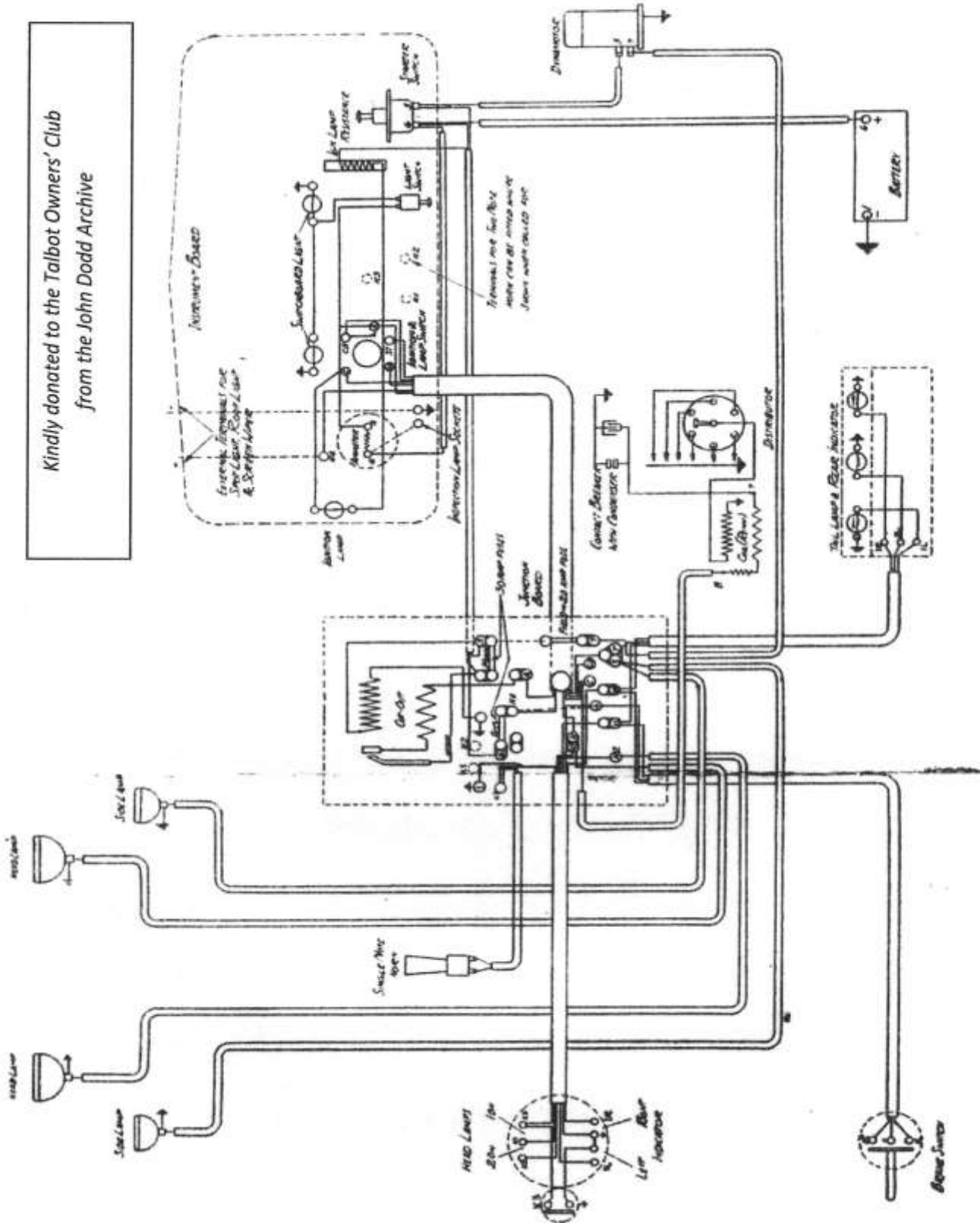

Terminal	Wire Color	Terminal	Wire Color	Terminal	Wire Color	Terminal	Wire Color
A	Green	10	Black	18	Green	26	Black
B	Black	11	Black	19	Black	27	Black
C	Black	12	Black	20	Black	28	Black
D	Black	13	Black	21	Black	29	Black
E	Black	14	Black	22	Black	30	Black
F	Black	15	Black	23	Black	31	Black
G	Black	16	Black	24	Black	32	Black
H	Black	17	Black	25	Black	33	Black

Switch Connection Diagram

Terminal	Wire Color	Terminal	Wire Color
A	Green	18	Green
B	Black	19	Black
C	Black	20	Black
D	Black	21	Black
E	Black	22	Black
F	Black	23	Black
G	Black	24	Black
H	Black	25	Black
I	Black	26	Black
J	Black	27	Black
K	Black	28	Black
L	Black	29	Black
M	Black	30	Black
N	Black	31	Black
O	Black	32	Black
P	Black	33	Black

All Lamp Bulbs are 12 V except parking lamp

# THE 14/45 H.P. SIX-CYLINDER TALBOT WIRING DIAGRAM. DASHBOARD JUNCTION BOX.

**SPECIFICATION**

DYNAMOTOR DM9/3  
 INSTRUMENT BOARD FT48/21D  
 & FT48/21DR  
 STEERING PILLAR SWITCH SP/CT2  
 CUT-OUT & JUNCTION BOARD 11960/2

**ROTAX LIGHTING & STARTING SYSTEM**

WIRING DIAGRAM FOR 12-VOLT EQUIPMENT (EARTH RETURN)  
 AS FITTED TO TALBOT "75" 17.9 H.P. CARS (1934)  
 (SHORT CHASSIS MODEL)

DR'G. No. S609-1

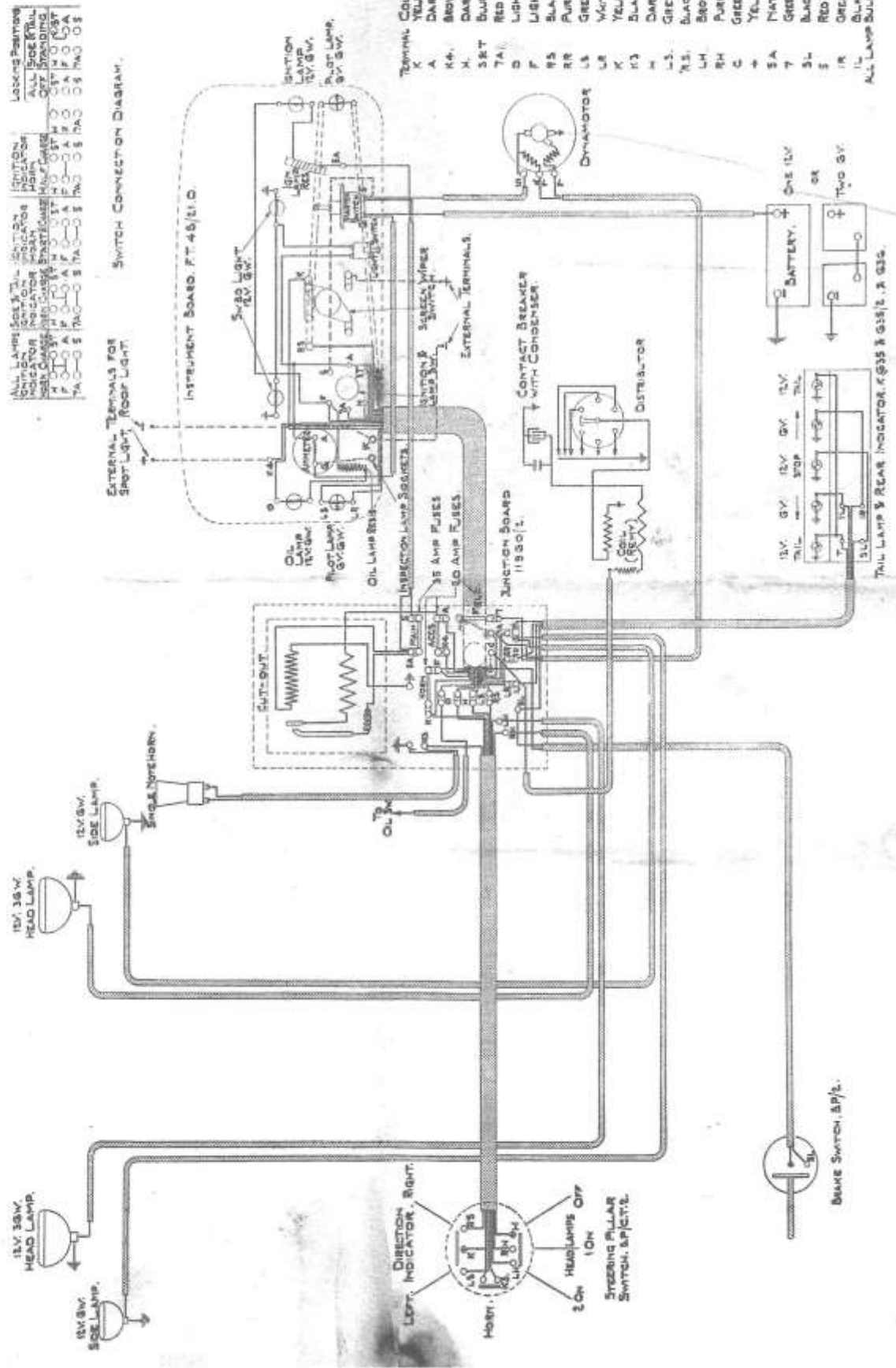





# WIRING DIAGRAM FOR 12-VOLT EQUIPMENT (EARTH RETURN) AS FITTED TO TALBOT "95" 20-9 H.P. CARS (1933-4)

BOARD FT4B/15  
STEERING PILLAR SP/CT2  
CUT-OUT & JUNCTION BOARD  
11930 OR 9253/3

LAMPS FOR IGNITION CHARGE	SECTION FOR CHARGE	POSITIONS
H O ST	H O ST	OFF
P O A	P O A	SIDE & TRAIL STANDING
C O CB	C O CB	H O ST
		P O A
		C O CB
		C O CB

SWITCH CONNECTION DIAGRAM.

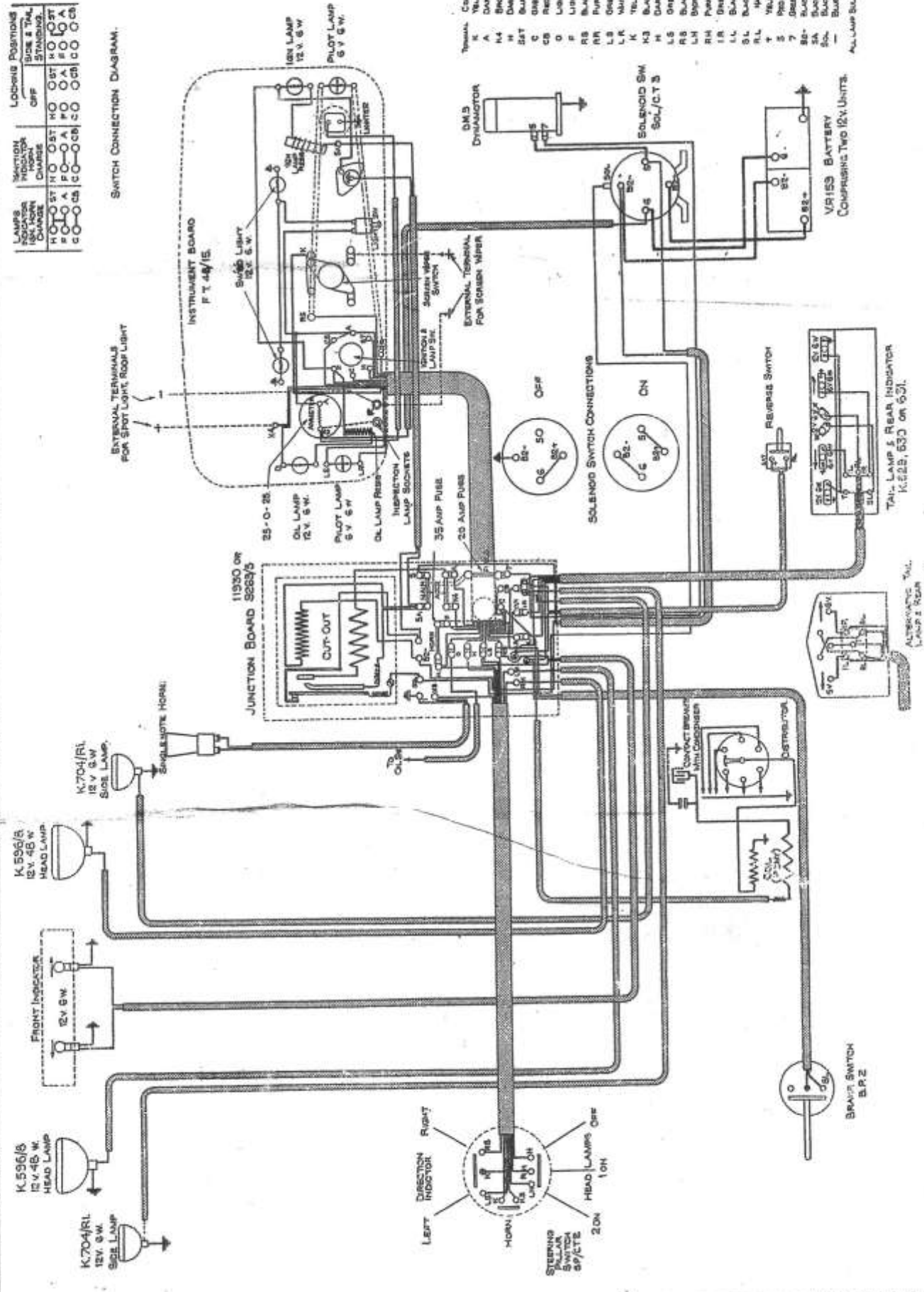

Terminal	Colour	Wiring
K	Yellow	Wiper Switch Feed
A	Dark Red	AMMETER TO CUT-OUT
M	Brown	Start Lamp, etc. Positive
H	Dark Blue	Head Lamp Positive
SET	Black Wire	Base To Lamp Positive
C	Orange Wire	Col. To Switch
CB	Red 4 Yards	Ignition Switch (200 Ohm)
D	Light Blue	Oil Switch
F	Light Red	Oil Indicator Positive
RB	Black Wire	R.H. Pilot Lamp
RR	Purple	R.H. Pilot Lamp
LB	Grey	L.H. Pilot Lamp
LK	White	L.H. Pilot Lamp
K	Yellow	1000 Ohm Resistor
K3	Black-Red	Wiper
H	Dark Blue	Head Lamp Positive
L5	Grey	L.H. Pilot Lamp
RB	Black Wire	R.H. Pilot Lamp
LB	Grey	Head Lamp L.
RR	Purple	Head Lamp R.
LR	Green	Head Indicator Positive
LL	Black	Head Indicator Positive
S L	Black/White	Stop Lamp - Positive
S L	Orange	Stop Lamp - Negative
Y	Yellow	Brake Switch Positive
5	Pink/White	Direction Indicator Positive
7	Green/White	Brake Switch Negative
20	Black/White	Brake Switch Negative
2A	Black/White	Brake Switch Negative
2B	Black/White	Brake Switch Negative
2C	Black/White	Brake Switch Negative
2D	Black/White	Brake Switch Negative
2E	Black/White	Brake Switch Negative
2F	Black/White	Brake Switch Negative
2G	Black/White	Brake Switch Negative
2H	Black/White	Brake Switch Negative
2I	Black/White	Brake Switch Negative
2J	Black/White	Brake Switch Negative
2K	Black/White	Brake Switch Negative
2L	Black/White	Brake Switch Negative
2M	Black/White	Brake Switch Negative
2N	Black/White	Brake Switch Negative
2O	Black/White	Brake Switch Negative
2P	Black/White	Brake Switch Negative
2Q	Black/White	Brake Switch Negative
2R	Black/White	Brake Switch Negative
2S	Black/White	Brake Switch Negative
2T	Black/White	Brake Switch Negative
2U	Black/White	Brake Switch Negative
2V	Black/White	Brake Switch Negative
2W	Black/White	Brake Switch Negative
2X	Black/White	Brake Switch Negative
2Y	Black/White	Brake Switch Negative
2Z	Black/White	Brake Switch Negative

ALL LAMP BULBS ARE GENERAL ELECTRIC TYPE

# ROTEX LIGHTING & STARTING SYSTEM

WIRING DIAGRAM FOR 12-VOLT EQUIPMENT (EARTH RETURN)

AS FITTED TO TALBOT "105" SPEED MODEL 20.9 H.P. CARS (1933-4)

## SPECIFICATION

DYNAMOTOR DM9 OR DM9/4  
 INSTRUMENT BOARD FT81/2  
 TEEING PILLAR SP/CT2  
 UT-OUT & JUNCTION BOARD 9223/3 OR 11930

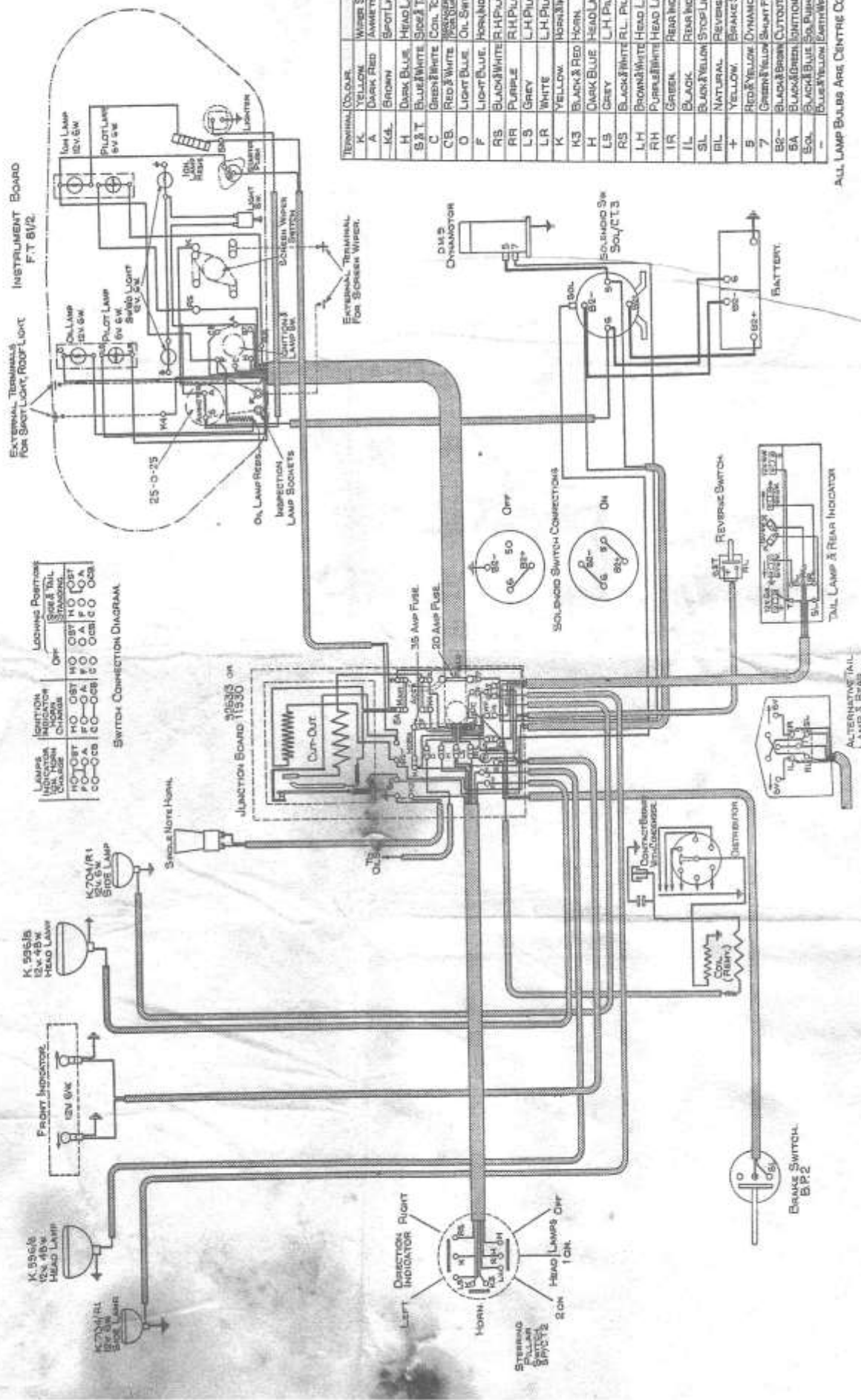

TERMINAL	COLOR	WIRING SWITCH
K	YELLOW	WIPER SWITCH RIGHT
A	DARK RED	WIPER SWITCH TO/OUT
K4	BROWN	SPOT LIGHT (E) POSITIVE
H	DARK BLUE	HEAD LAMP POSITIVE
S & T	BLUE/WHITE	SPOT & TAIL LAMP POSITIVE
C	BROWN/WHITE	CON. TO SWITCH
CB	RED & WHITE	WIPER SWITCH TO/OUT
O	LIGHT BLUE	OIL SWITCH
F	LIGHT BLUE	HORN INDICATOR POS
RS	BLACK/WHITE	R.H. PILOT LAMP
RR	PURPLE	R.H. PILOT LAMP
L5	GREY	L.H. PILOT LAMP
LR	WHITE	L.H. PILOT LAMP
K	YELLOW	HORN INDICATOR SW. REAR
K3	BLACK & RED	HORN
H	DARK BLUE	HEAD LAMP POSITIVE
L5	GREY	L.H. PILOT LAMP
RS	BLACK/WHITE	R.L. PILOT LAMP
L.H	BROWN/WHITE	HEAD LAMP L.
R.H	PURPLE/WHITE	HEAD LAMP R.
I.R	GREEN	REAR INDICATOR R. POS.
I.L	BLACK	REAR INDICATOR L. POS.
S.L	BLACK & YELLOW	STOP LIGHT POSITIVE
R.L	NATURAL	REVERSE LIGHT POSITIVE
+	YELLOW	BRAKE SWITCH POSITIVE
5	RED & YELLOW	DYNAMOTOR POSITIVE
7	GREEN/YELLOW	SWAY FIELD POSITIVE
80-	BLACK & BROWN	CUTOFF NEGATIVE
5A	BLACK & GREEN	IGNITION WARNING LAMP
50A	BLACK & BLUE	50A BULB SW. POSITIVE
50L	BLACK & YELLOW	50A BULB SW. POSITIVE
-	-	50A BULB SW. POSITIVE

ALL LAMP BULBS ARE CENTRE CONTACT TYPE

# ROTEX LIGHTING & STARTING SYSTEM

## WIRING DIAGRAM FOR 12-VOLT EQUIPMENT (EARTH RETURN)

### AS FITTED TO TALBOT "95," "105" & 3½ LITRE CARS (1935)

#### SPECIFICATION

- DYNAMOTOR DM9/4
- INSTRUMENT BOARD FT97/3
- STEERING PILLAR SWITCH SP/CT2
- CUT-OUT & JUNCTION BOARD 11930

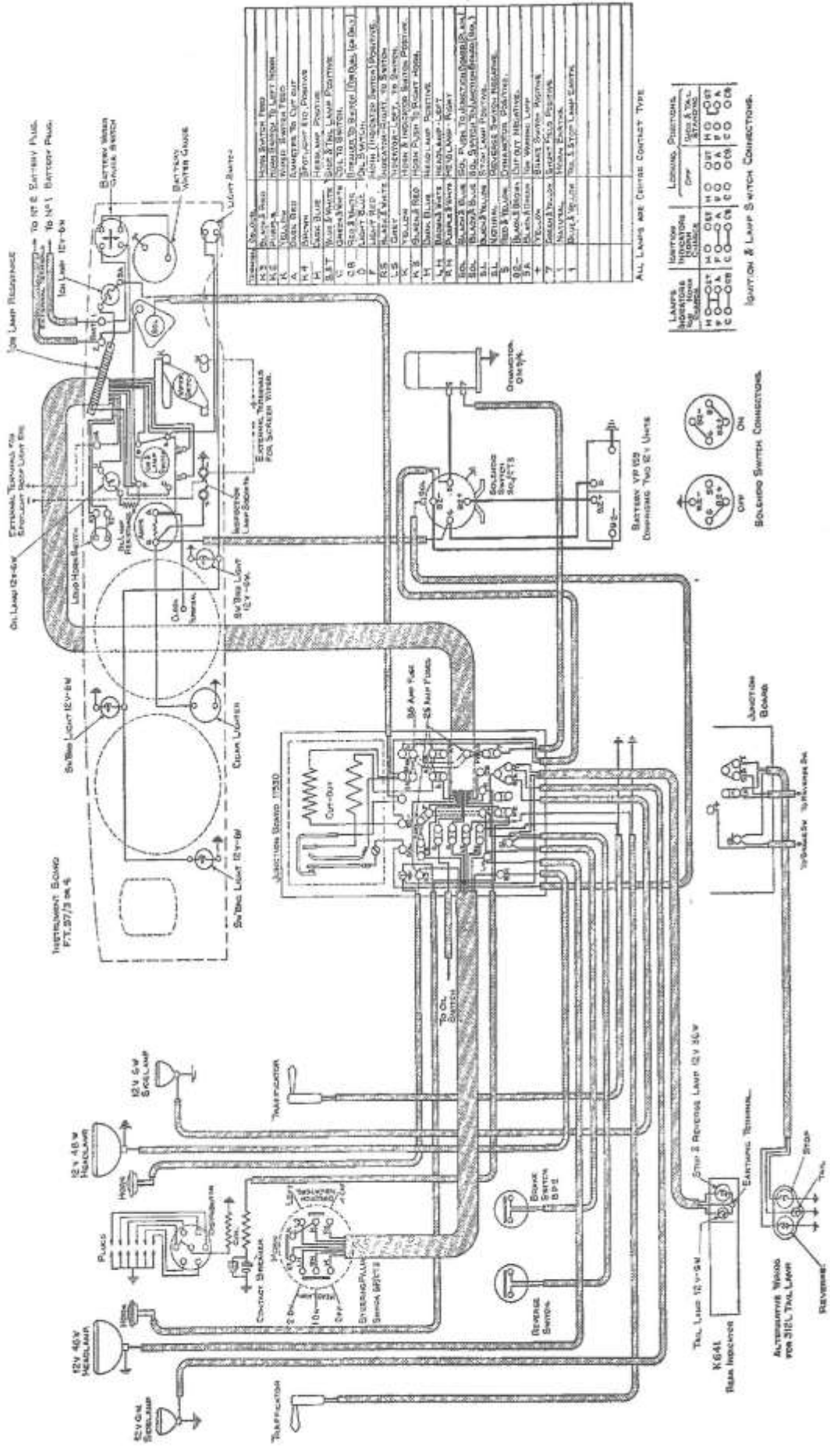

# WIRING DIAGRAM No. W.450

## SPECIFICATION OF EQUIPMENT.

Dynamo	C5H	BQ2-0
Starter	M45AL	S3-5
Regulator and fuse unit	RJF20	1.38
Battery	STW11A/12	

## BULBS.

Headlamps:—Lucas No. 30  
 Sidelamps:—Lucas No. 207  
 Stop tail lamps:—Lucas No. 207  
 Ignition warning light:—  
 No. 252 M.E.S.  
 "Trafficators":—Lucas No. 256.  
 Reverse lamp:—Lucas No. 1

## FUSES

Headlamps:— 25 amperes  
 Sidelamps:— 25 amperes  
 Accessories:— 25 amperes  
 Dipping reflector:—4.5 amperes

## INTERNAL CONNECTIONS OF LIGHTING AND IGNITION SWITCH.

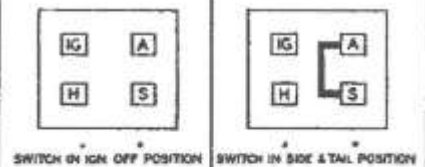
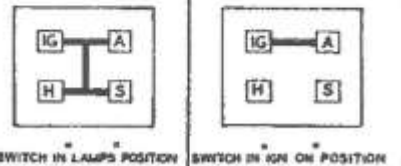

KEY LIST OF COLOURS

1	RED
2	RED & YELLOW
3	RED & WHITE
4	RED & BLACK
5	YELLOW
6	YELLOW & BLUE
7	YELLOW & BROWN
8	YELLOW & PURPLE
9	BLACK & YELLOW
10	BLACK
11	WHITE & BLUE
12	WHITE & PURPLE
13	WHITE
14	GREEN
15	GREEN & BLACK
16	PURPLE
17	PURPLE & BLACK
18	BLACK

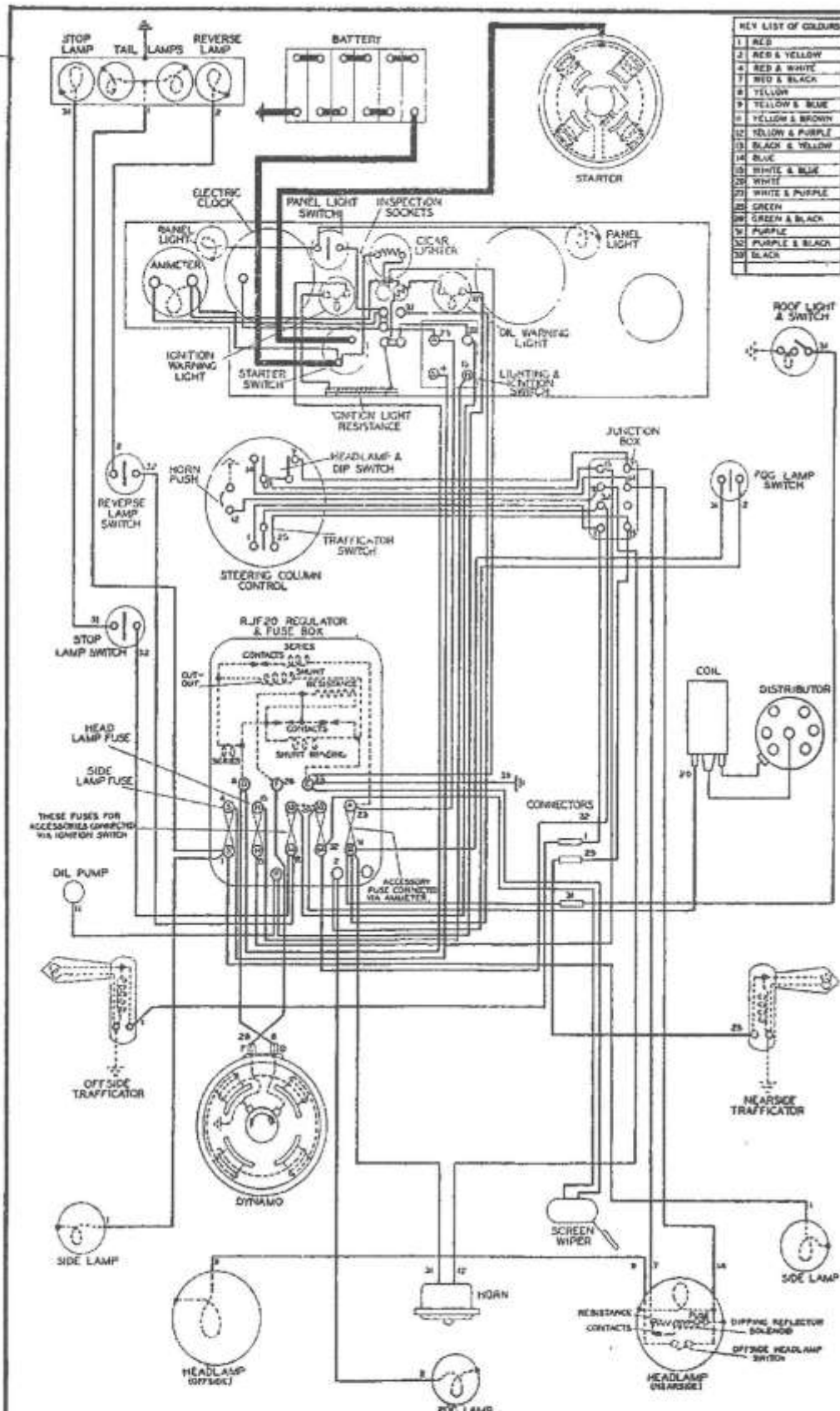

NOTE. Twin horns are fitted on the "105" Model  
 Internal connections shown dotted.  
 Numbers indicate cable identification colours. See key above.

# LUCAS 12-VOLT ELECTRICAL EQUIPMENT

AS FITTED TO

# TALBOT "75," "105" & "105 SPEED" CARS (1936)

#1125/4

Printed in England.

# WIRING DIAGRAM No. W.441

## SPECIFICATION OF EQUIPMENT.

Dynamo	C5H	BQ2-0
Starter	M45AL	S3.5
Regulator and fuse unit	RJF20	L38
Battery	STW11A/12	

## BULBS.

- Headlamps:—Lucas No. 30
- Sidelamps:—Lucas No. 207
- Stop tail lamps:—Lucas No. 207
- Ignition warning light:—  
No. 252 M.E.S.
- Trafficators:—Lucas No. 256
- Reverse lamp:—Lucas No. 1

## FUSES.

- Headlamps:— 25 amperes
- Sidelamps:— 25 amperes
- Accessories:— 25 amperes
- Dipping reflector:— 4.5 amperes

## INTERNAL CONNECTIONS OF LIGHTING AND IGNITION SWITCH.

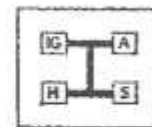

SWITCH IN LAMPS POSITION

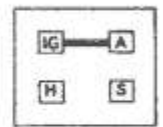

SWITCH IN IGN ON POSITION

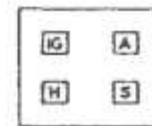

SWITCH IN IGN OFF POSITION

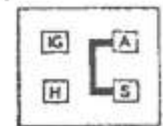

SWITCH IN SIDE & TAIL POSITION

1	RED
2	RED & YELLOW
3	RED & WHITE
4	RED & BLACK
5	YELLOW
6	YELLOW & BLUE
7	YELLOW & BROWN
8	YELLOW & PURPLE
9	BLUE
10	BLUE & WHITE
11	WHITE
12	WHITE & GREEN
13	WHITE & PURPLE
14	GREEN
15	GREEN & BLACK
16	PURPLE
17	PURPLE & BLACK
18	BLACK
19	BLACK & YELLOW

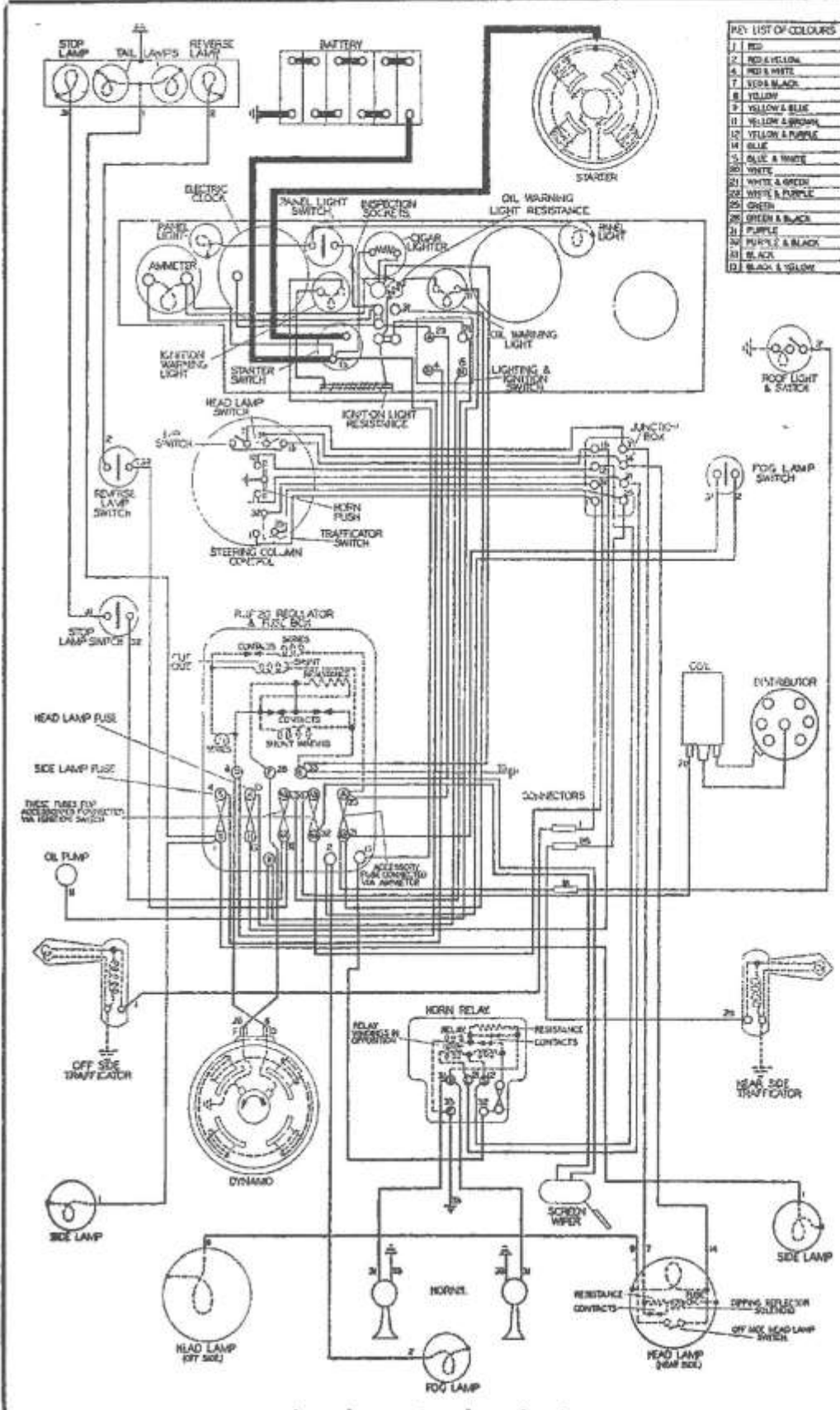

Internal connections shown dotted.  
Numbers indicate cable identification colours. See key above.

# LUCAS 12-VOLT ELECTRICAL EQUIPMENT AS FITTED TO TALBOT 3½ LITRE CARS (1936)

# ROTAX SWITCHES

By Michael Marshall

The Rotax barrel switches used on Talbots appear very robust and, I'm sure, were very reliable when new but now, after eighty years of use and repairs of varying competence, can become very unreliable. The reason for this is that although their construction *seems* reassuringly massive, their electrical integrity depends crucially on the precision fit of the shouldered insulators used to locate and secure together the phosphor-bronze wiper springs and connecting tabs in the grooves in their mounting strips, whilst ensuring no shorting to the frame.

The holes in the wiper springs and connecting tabs will still be correct, but the shouldered insulators were made of an insulating material which becomes brittle over time and is liable to crumble or split if the securing screws are over tightened. The shank length of these insignificant little items is critical. If less than the thickness of the connecting tab

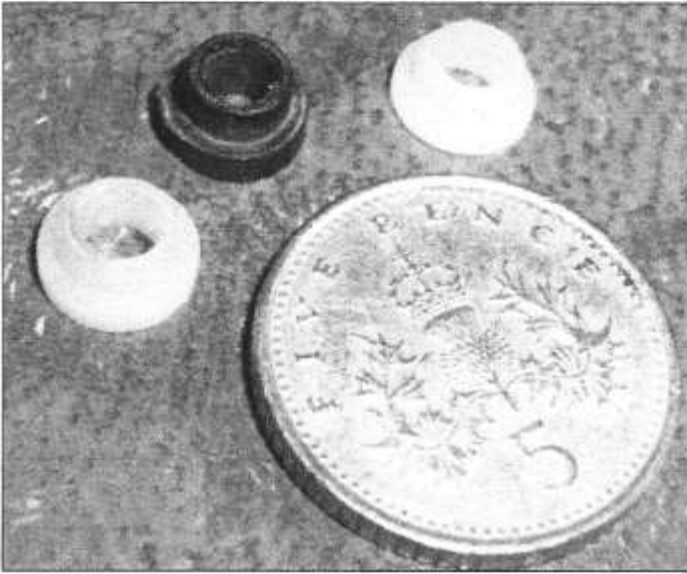

Figure 1: Tiny Insulators.

Similarly, the slotted mounting strips can become deformed and split, permitting the wiper spring to get out of line and make electrical contact with another brass contact on the barrel that the designer never intended, see Figure 2.

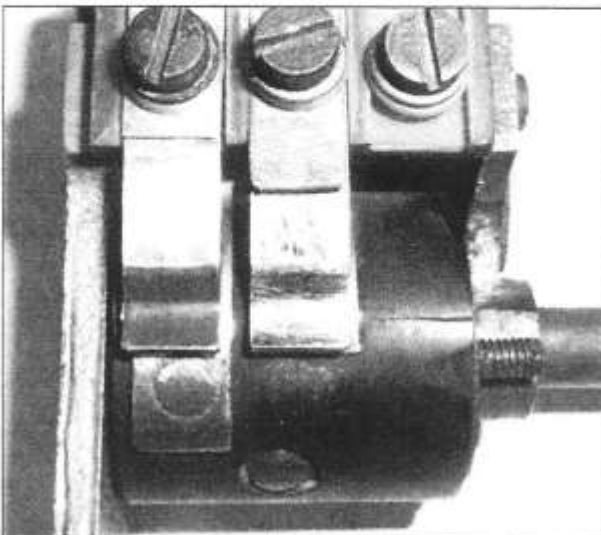

Figure 3: Switch with re-aligned barrel.

they will not engage the spring sufficiently to ensure its correct location. If more than the combined thickness of the tab and spring they will not allow positive electrical contact between tab and spring and between the spring and the brass intended brass contact on the barrel (even though the screw is fully tightened), allowing sparking, overheating and premature failure.

Using a lathe it's a simple matter to make new insulators which provide a good fit in the springs and tabs - and the correct shank length - from any of the much stronger plastic materials now available. Figure 1 shows some made from an acetate material.

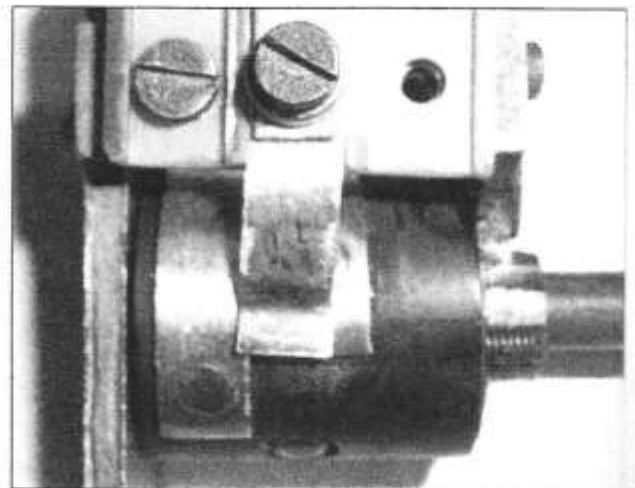

Figure 2: Switch with misaligned wiper spring.

On another switch the axial location of the barrel with respect to the wiper springs was, for some inexplicable reason, not correct, being 2mm too far to the rear (of the car). Taking 2mm off the front of the barrel and fitting a 2mm spacer at the rear cured the problem, see Figure 3.

Fondly imagining that I had sorted out my switch problems, at least for my life time, I was recently annoyed to find, when investigating a sudden loss of side and tail lights, that the middle wiper spring was not making positive contact with its corresponding brass contact on the barrel - even though its fixing was tight.

Clearly, it needed a little tweak to make it press inwards more firmly. I was about to remove the switch to do this, (which I was not looking forward to because of the four tiny countersunk screws which have to be removed, and replaced, behind the panel) when I had a brainwave. Why not remove just the barrel, leaving the rest of the switch, its fixings and connections entirely undisturbed, and 'set' the wiper spring to provide better contact?

This also avoids having to remove any adjacent item to gain access to the electrical connections. It requires only the removal of the two cheese head screws and the triangular spring plate for the ball detent, the extraction of the ball with your magnetic retriever, and the removal of the two countersunk screws in the switch frame so that the barrel, with its front bearing, can be pulled clear, see Figure 4.

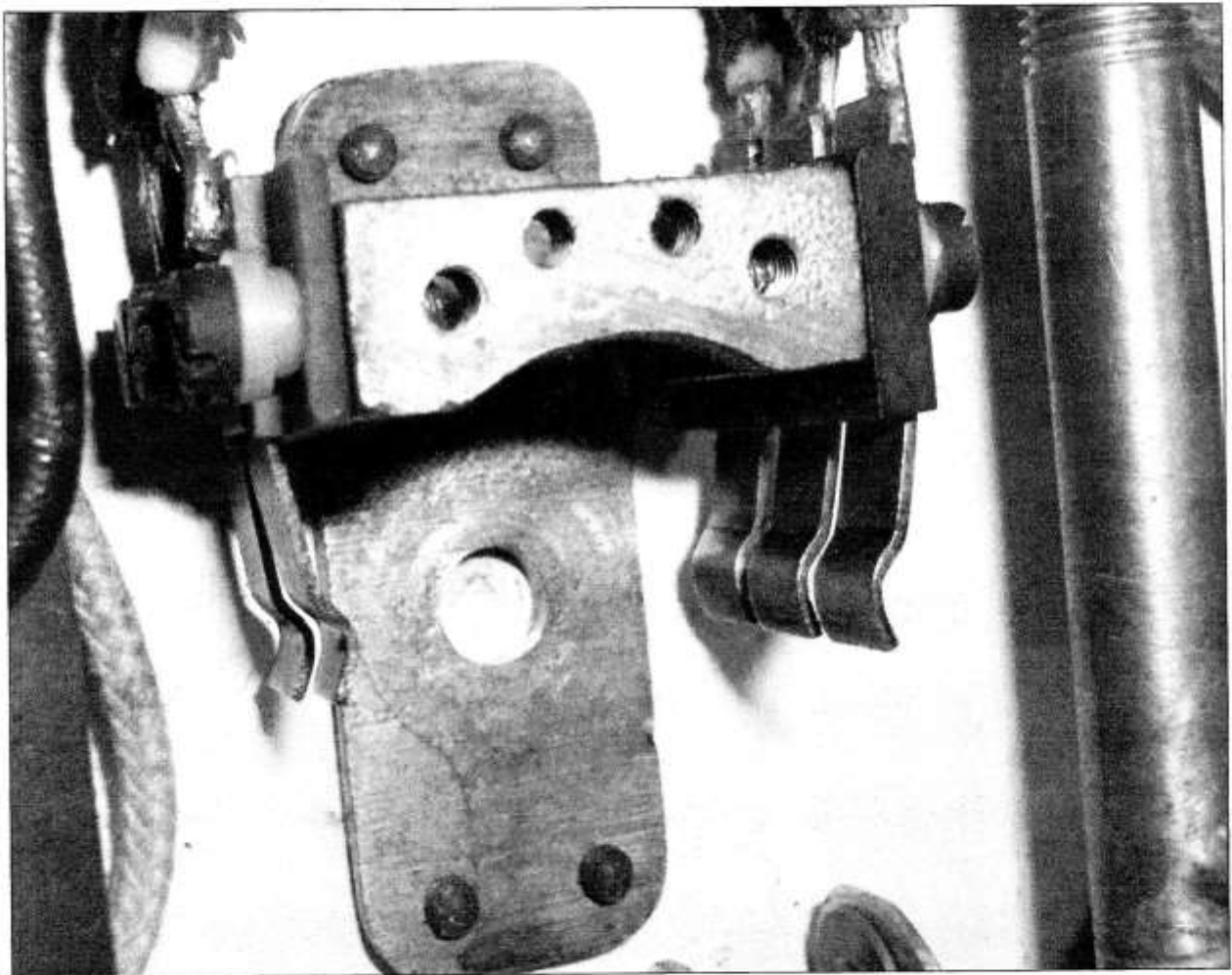

*Figure 4: Switch frame and barrel removed.*

You then have unobstructed access to any spring that may require tweaking to provide proper contact with the brass strips on the barrel. To reassemble, you simply re-insert the barrel, replace the countersunk screws, then the ball and triangular spring detent plate.

Simples!



# LET THERE BE (ADEQUATE) LIGHT!

By Ian Potts

I enjoy driving my Talbot, but over the years I have found night time driving more difficult. Modern lights seemed to be getting brighter and brighter (or am I just getting older?) resulting in my Talbot's lights appearing dim in contrast. A simple solution would be to fit some small modern freestanding headlights as driving lights, but as I didn't want to do this I set about trying to improve my headlights.

The voltage drop between the battery and head lamp bulb was measured at about 2 volts, giving me quite a shock. The power of the lights is proportional to the voltage squared so this represented a very significant loss of around 30%. A hefty earth wire from the headlamps to a chassis earthing point made a large difference as did relays to operate the headlamps cutting down the length of the power cable required. I also had my reflectors resilvered which helped a bit, but having them aluminium coated (as in a modern headlamp) was an even greater improvement.

I next tried halogen bulbs (40/45W) as it is claimed these give out more light than conventional bulbs without using any more power, and these did make a significant improvement. The lights were now very good, like two enormous searchlights. However they didn't dip very far, and the dipped beam was circular in shape. To avoid dazzling other road users the lights had to be set very low on the dip setting with the result that the main beam setting was pretty useless.

By mistake (all connected with making a flashing wand for the Queen of the Fairies in Iolanthe – but that's another story!) I ordered some other halogen bulbs that gave me a fantastic dipped beam, flat topped and reasonably wide as in a modern car. The main beam was also tremendous, though not very wide (making driving fast at night on curving roads quite tricky.) When I examined the bulbs they differed in two ways from my previous bulbs:

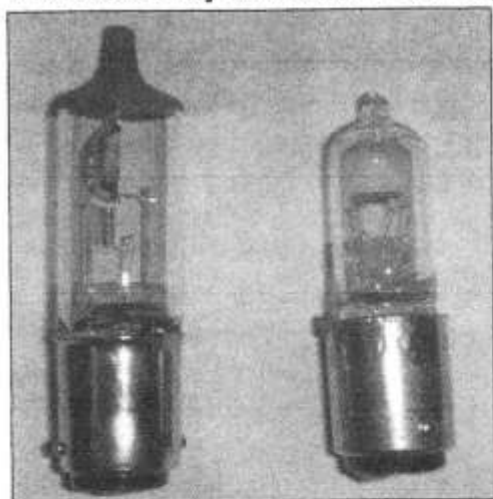

Above: The bulb on the left gave the good dipped beam

- a. The filaments ran parallel to the length of the car as in a modern bulb, not across the car as a pre-war filament does. I assume this gives a bigger dipping angle.
- b. The dip filament has a shield above it which I imagine gives the nice cut-off shape to the dipped beam.

The only problem (life is never easy is it?) was that they were only available in 55/60W form. The 105 dynamotor will put out 15 amps (i.e. about 180 watts) so two 60 watt bulbs seemed possible. However four side light bulbs, a number plate bulb plus two instrument illumination bulbs consumed another 42 watts and there was still the ignition requirements of 30-40 watts. And what about the wiper? Without the wiper the requirements were of the order of 200 watts which was too much.

Enter my saviour in the form of LED bulbs. I found these quite by chance on a motorcycle web site. You can buy them in bayonet form that simply plug into your existing light fittings. I replaced my sidelights, number plate and instrument illumination bulbs gaining about 40 watts. The ammeter doesn't even move when I switch my side lights on! I now have superb headlights plus a little surplus charge when on main beam (maximum charge is about 14 amps). And when it rains? Well I use Rainex so I hardly ever use my wipers (in fact they are only ever used at the MOT!)

My other lighting modification has been to fit flashing indicators. Driving in modern traffic conditions without them is foolhardy in my opinion. I have had them for years. Originally I had twin filament bulbs in my side lights giving a red flash at the rear and a white one at the front. I soon changed the rear to a separate 'pork pie' lamp with an orange lens as this was far more visible to other drivers. I was still unhappy with the white flashing indicators at the front, even though they are legal modern motorists don't always understand. Recently I discovered orange indicator bulbs which are now fitted in my front side lights so I have orange indicators at the front as well. I have

had to fit frosted glass lenses to disguise the bulbs. I fitted some white LEDs in the front side lights as well, so my sidelights are white, but flash in orange. I'm not too happy with the result from an aesthetic point of view as the white light from an LED bulb is a very different colour from an incandescent bulb. However I do feel much safer driving in modern traffic.

I have used all the above quite happily for several years, but in the back of my mind has always been the worry that I was overloading the dynamotor as perceived opinion is not to draw more than 12 amps. I was discussing this with the headlamp bulb manufacturer at Beaulieu this year, and he said that he now produces these bulbs in a 35W/35W form which he said would be more than adequate. I have now fitted these, reducing the dynamotor output to 12 amps, and still have charge when running with the headlights on. The headlights are not as bright, but are more than adequate with a good dipped beam.

### **Technical points.**

LED bulbs are now available in 'super bright' form, which I have found much better than the standard form.

LED bulbs don't spread their light like an ordinary incandescent bulbs. Bulb suppliers have now produced 'wide angle' versions with some of the LEDs placed facing sideways.

Red LEDs are more efficient than white ones. Don't put a white LED behind a red lens, a much better result is obtained by using a red LED behind a red lens.

I found that a double filament white LED in the front side lights was not very satisfactory. When the side lights were on the difference in brightness when flashing was not great enough to be really obvious.

LED bulbs are more expensive but they will last for a very long time as they are vibration proof.

Don't forget the reflectors in your side lights. Humble silver foil stolen from the kitchen made an amazing difference to my rear lights, while a can of 'chrome look' aerosol spray improved the side light reflectors.

Most orange indicator bulbs have a different position for the holding pins and require one of the pins to be filed off or the bulb holder to be modified. The other solution (which I have used on my son's Austin 7) is to paint ordinary bulbs orange. Small bottles of glass paint are readily available for a couple of pounds in local craft shops.

### **Suppliers**

*(Usual disclaimer – I have no connection with these suppliers other than being a satisfied customer)*

LED bulbs: I found many suppliers using the web, but I found Ultra LEDs, 2 Store Street, Bollington, Cheshire, SK10 5PN Tel 01625 576778 or [ultraleds.co.uk](http://ultraleds.co.uk) to be fast, efficient and cheap. I have also sourced some from China using EBAY shops, these were cheap and worked just as well.

Halogen Bulbs: Andrew Brock (Bulb Supplies), 31A Shawbury Road, Dulwich, LONDON SE22 9DH Tel 0208 2990299. The style required is H4 (not H5 which is the pre-war pattern) with a Ba15d base (if you have 15mm bayonet with double contacts)

'Chrome look' aerosol spray: Frost Auto Restoration Techniques Ltd, Crawford Street, Rochdale, Lancashire OL16 5NU Tel 01706 860338 or [www.frost.co.uk](http://www.frost.co.uk)

### **Postscript on dynamotor .**

While you are measuring voltage drop, measure the voltage drop between the battery and the dynamotor when starting. You may well be shocked! I was losing around 25% of the available power, a lot of it across a master switch that had been fitted. Bypassing the master switch reduced that loss to 15%, resulting in a much faster turn over when starting. Arthur Archer's notes state that there is an extra 15% torque available with the shunt field energised, so I always use the maximum charging switch position when starting (I have fitted Michael Marshall's charging switch modified to give three charging rates – a great success!)

# 'LET THERE BE (ADEQUATE) LIGHT'

By Ian Potts

**Xenon Bulbs.** Robert May phoned me up to enquire about xenon bulbs which are more light efficient than halogen ones. There are two types of xenon headlamps, xenon HID and bulbs where I think the halogen gas is replaced by xenon.

HID stands for High Intensity Discharge, and refers to the technology involved which is a spark across a gap like an arc lamp rather than a glowing filament. These take time to warm up which means that the dipped beam must stay on when you are on main beam otherwise when you dip your lights you would have a second or so of comparative darkness. You need some specialised electronics to control the bulb and the Road Vehicle Lighting Regulations demand that the vehicle must have headlamp cleaning and self-levelling (either of the headlamp or the suspension). All of this involves more modification than I am prepared to do to my Talbot!

Replacing halogen gas by xenon (or is it a mixture of these gases?) seems much more promising for us. Philips now produce a bulb called 'Xtreme Power +80%' which gives out 80% more light than a normal halogen bulb, so a 35W version of one of these would be ideal. So far these are not made to fit in our type of headlights, but I am emailing the manufacturer who I met at Beaulieu this year to see if he intends to produce them. Some people think it won't be long before we see high intensity LED headlight bulbs or maybe someone will manufacture some 10 inch reflectors that take modern bulbs.

If you want more power than the Talbot dynamotor can produce, have a look at the modification that Philip Warrener has done. He has strapped a dynamo to the side of his dynamotor driven by a taperlock pulley fitted over the starter dog. Neat, totally reversible and hidden so even the VSCC would approve!

**Indicators.** Another query I received was about the use of LED bulbs in flashing indicators. LED bulbs will not work correctly with most flasher units unless you add resistors, and then you end up not saving any power. I use normal incandescent bulbs in my indicators as the spread of light is better, and the power saving is not an issue as indicators are not on for long.

Since the last article I have found a extremely small indicator bulb which means that fitting a side light bulb and an indicator bulb into a sidelight is an absolute doddle. The photograph (right) shows how small the bulb is.

I made up a bulb holder that replaced the usual bulb holder (left photo opposite). As you can see this allows the original reflector to be used with no modification (centre and right photos opposite).

If you don't like LED bulbs you can buy incandescent bulbs the same size as the LED bulb that I have used. Note that this is a totally reversible modification.

It might be thought that another solution would be to incorporate the sidelight bulbs in the headlights and put orange indicator bulbs in the sidelights. Apart from having to drill a hole in your reflectors (which I don't want to do) you won't be able to use an LED bulb as the

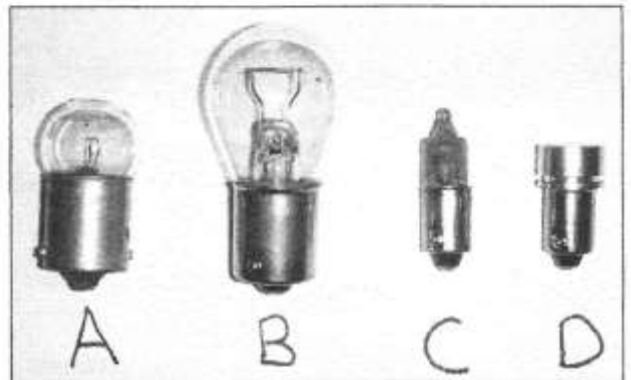

A is a normal BA15 sidelight bulb.  
B is a normal BA15 indicator bulb.  
C is a small BA9 indicator bulb (23 watt)  
D is a BA9 LED sidelight bulb.

side light bulb as the heat put out by the headlight will quickly destroy the LED bulb.

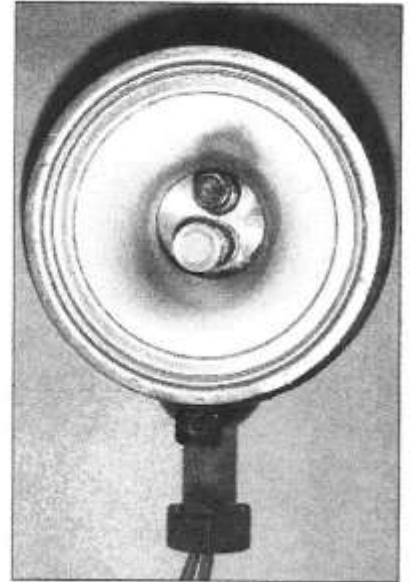
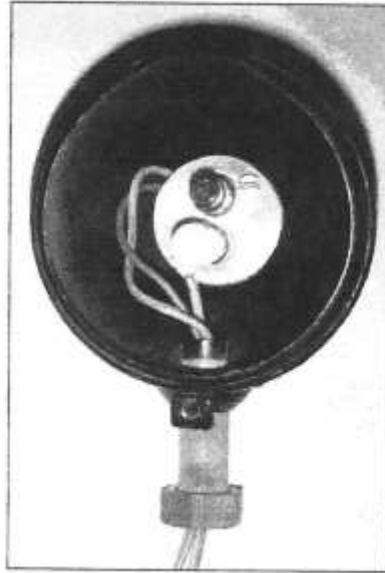
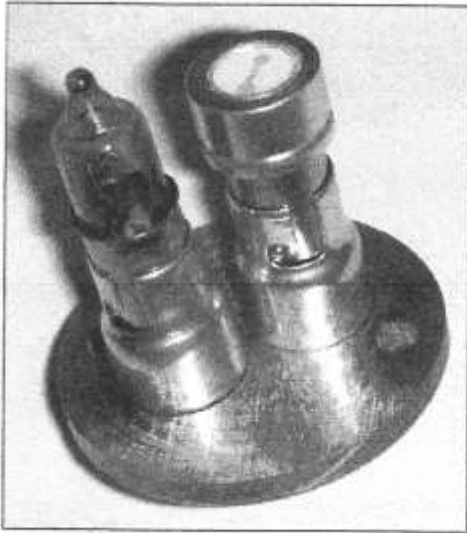

**Suppliers.** *(usual disclaimer – I have no connection with these suppliers other than being a satisfied customer)*

Vehicle Wiring Products (0115 9305454 or [www.vehicleproducts.co.uk](http://www.vehicleproducts.co.uk)) for the indicator bulbs (part number BLB07), bulb holders (part number 170136) and non-LED sidelight bulbs (part number 233)

Ultra LEDs at [www.ultraleds.co.uk](http://www.ultraleds.co.uk). Click on 'automotive LED bulbs', 'BA9s', 'White' and second on the list should be BA9 - 1W wide angled high power LED bulb Xenon white.

# LIGHTING UPDATE

By Ian Potts

Since my last article LED technology has forged ahead so I felt a report on recent developments would be useful.

I am very keen on flashing orange indicators at the front of the car, but done in such a way that the original appearance is kept. I previously did this by inserting two small bulbs, one orange and one white, into the sidelights. Now dual colour LED bulbs are available that will fit into offset pin bulb holders. I am aware of two different types. a. A small bulb (see diagram 1) which looks quite strange. The yellow circles emit white light, the white circles emit orange light and the circles behind the front emit light sideways to light up the reflector. The bulb is bright but the source of light shows as distinct small circles. This bulb performs well behind a frosted lens, which also has the advantage of hiding the strange appearance. b. A larger bulb (see diagram 2). When one pin is energised it emits white light, when the other pin is energised the white light is turned off if it is on and orange light is emitted. This bulb is very bright, the white light having a claimed equivalent rating of 21W.

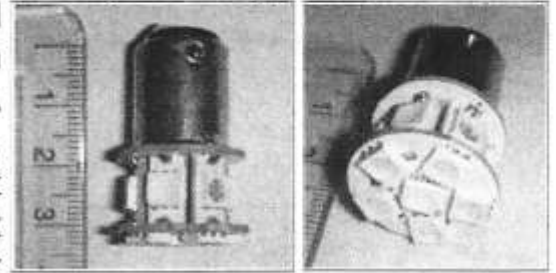

Diagram 1

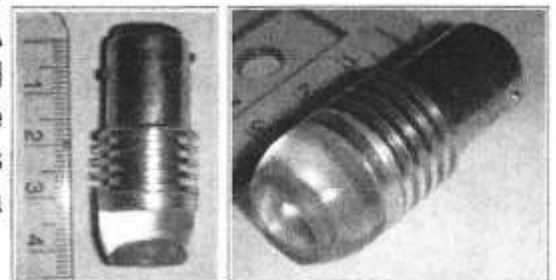

Diagram 2

I fitted the larger bulbs and painted the plastic with a thin coat of yellow glass paint so the white light is more like an incandescent bulb. However for some sidelights there won't be enough room for these bulbs, I had to make special bulb holders for one car. My MOT man was a little unhappy about these bulbs because if the sidelights are on and one starts indicating, then the sidelight on that side goes out. He thought the lights were fantastic and he understood the reason why the sidelight went out, but he did say that an MOT requirement is that the operation of any one light must not affect any other light. However I still got an MOT! These bulbs are so bright they can be used as daylight running lights if required.

Another problem at the MOT was that the front sidelights came on when I pressed the brake pedal. I had never worried about this before, but the MOT man was not happy. On this car I have dual function LED bulbs fitted at the rear which act as rear lights and brake lights. I discovered that when the bulb's brake light pin was energised, about 7V appeared on the sidelight pin which was sufficient to feed forwards and light up the front sidelights. A diode in the sidelight circuit solved this problem.

LED headlight bulbs are now available. They purport to be equivalent to 50W yet only use 0.75 amps. The light source is not as compact as the usual bulb, so the light produced spreads out more, giving a pool of light rather than the searchlight beam we are accustomed to. One person I know has tried them on a Gwynne and says they are fantastic, it is the first time he has been able to see where he is going at night. Only the equivalent of single filament bulbs are available which means they can only realistically be used in spotlights or headlights with dipping reflectors, but a dipping version is under development. Visit [www.dynamoregulatorconversions.com](http://www.dynamoregulatorconversions.com) and go to the 'What's New' page for more information and pictures of vintage cars using these bulbs at night.

A comment from Martin Bryant about how easy it had been to see Ian Polson when they were in Alpine mist and fog as Ian had fitted rain lights made me think about fitting rear fog lights for the recent Italian trip. I also knew that if I did this, then we would be guaranteed fantastic weather in the Alps and I would never need to use them. I was proved right! I found some 11W LED festoon bulbs which fitted neatly into my rear porkpie lamps giving an extra 22W of light per lamp. (See diagram 3). A worthwhile safety modification if you use your car in murky weather, especially on motorways.

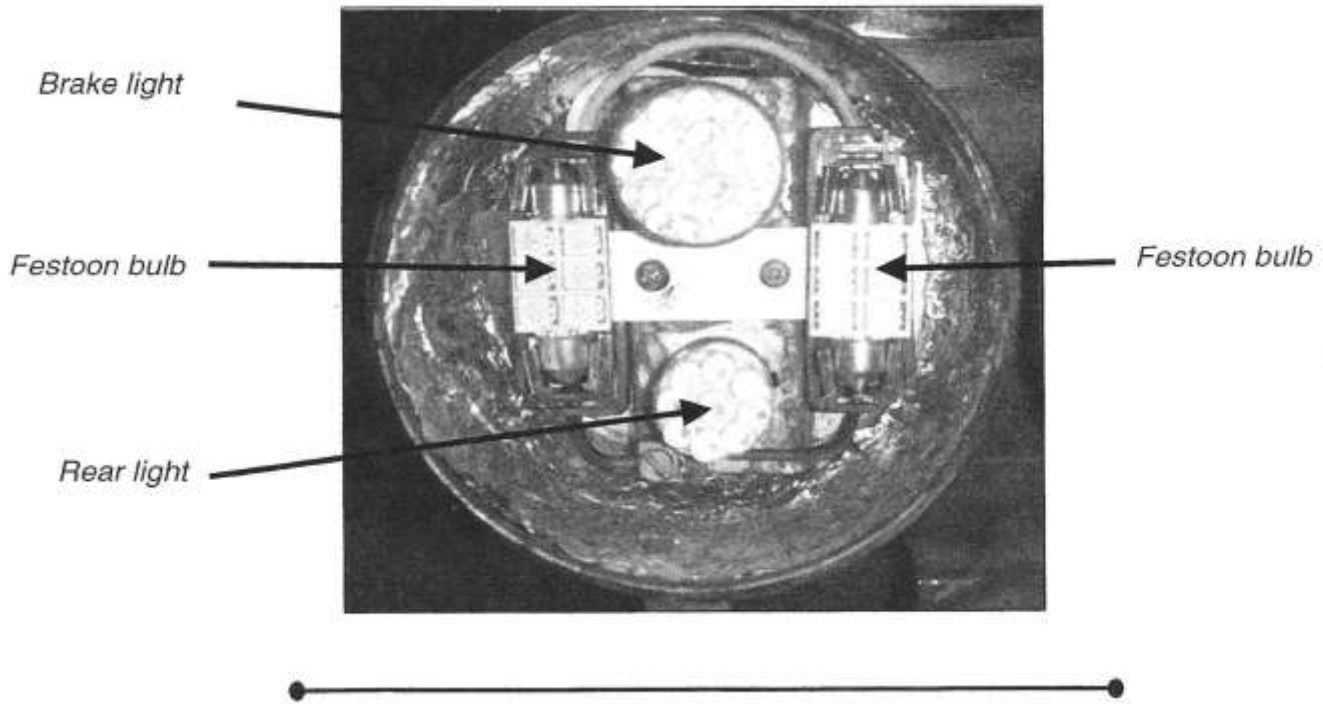

**Lucas windscreen wipers as fitted to MJ 8243**  
**Notes made around 1977/78 by Peter Richardson**

RACK 743235

This has a stroke of 22 teeth which with a 9-tooth wheel equals 145 degrees

Motor is marked: 12v 54071135F DR3A 67 754 500

Terminals;

Green (2) to +ve,

E to earth -ve

1 to switch

Switch from 1 to E (This wiper parks on nearside with rack in: ie switch is in -ve line)

1. Outer tube 15 ½ inch overall length
2. Outer tube with union nut 20 inches min from end to end
3. Rack to be 43 inches min from hole
4. 2 Off wheel and spindle assembly 1 ½ inch boss 22 teeth wheel boxes marked 75851A (A may mean aluminium boss)

Inboard position of rack hole is 2 ¾ inches from end of tube

Boss overall length is reduced to 3/8 inch, knurled bosses removed.

Mounted symmetrically under windscreen 15 ½ inches apart, using tube 13 ½ inches long.

Tube from motor to first wheel box is 25 inches

Stroke = 9 teeth is approximately 1 3/16 inches the wheel is marked "150 degrees"

Notes on Lucas wiper motors and gearboxes

Number	Stroke	Notes
I	145 degree wipe 9 teeth (1 3/16 inches)	Marked 150 degrees 12v 54071135F DR3A 67 754 500
II	7 Teeth (1 inch)	Marked 130 degrees Big end appears worn
III	7 Teeth (1 inch)	Marked 138 degrees Big end appears worn No switch
IV	100 degree wipe 6 teeth (13/16 inch)	Marked 100 degrees Good condition 540711 45 754494 DR3A 12v 3 63

Wheel box data

degrees	90	120	150	180
7 teeth	28	21	17	14
9 teeth	36	27	21	18

Wheel = rack x 360/angle

# Notes